

Function Fittings

Flow Control Regulators

Piloted Function Fittings

Non-Return Valves

LIQUIfit®

Pressure Fittings

Other Function Fittings

Silencers



Function Fittings

Flow Control Regulators

(P. 4-6)



Function: controls the speed of the cylinder rod
Materials: polymer, metal, stainless steel
Pressure: 10 bar
Temperature: 0°C to +70°C
Ø metric: 3 mm to 18 mm
Threads: BSPP, BSPT, metric

Blocking Fittings

(P. 4-36)



Function: provides safety by locking the cylinder piston
Materials: nickel-plated brass, polymer
Pressure: 10 bar
Temperature: -20°C to +70°C
Ø metric: 6 mm to 12 mm
Threads: BSPP, BSPT

Piloted Non-Return Valves

(P. 4-38)



Function: provides safety by locking the cylinder piston
Materials: nickel-plated brass, polymer
Pressure: 10 bar
Temperature: -5°C to +60°C
Ø metric: 6 mm to 12 mm
Threads: BSPP

Non-Return Valves

(P. 4-40)



Function: allows air to pass in one direction only
Materials: polymer, nickel-plated brass
Pressure: 10 bar
Temperature: 0°C to +70°C
Ø metric: 4 mm to 12 mm
Threads: BSPP, BSPT, metric

Adjustable Non-Return Valves

(P. 4-42)



Function: allows air to pass in one direction with an adjustable opening pressure
Materials: FDA chemical nickel-plated brass
Pressure: 12 bar
Temperature: -20°C to +80°C
Threads: BSPP, metric

LIQUIfit® Non-Return Valves

(P. 4-44)



Function: allows fluid to pass in one direction only
Materials: polymer for food applications
Pressure: 10 bar
Temperature: 0°C to +65°C
Ø inch: 1/4" and 3/8"

Stainless Steel Non-Return Valves

(P. 4-46)



Function: allows fluid to pass in one direction only
Materials: stainless steel
Pressure: 0.5 to 40 bar
Temperature: -20°C to +180°C
DN : 10 mm to 25 mm
Threads: BSPP, NPT

Soft Start Fittings

(P. 4-48)



Function: protects the installation at start-up
Materials: polymer, nickel-plated brass
Pressure: 3 to 10 bar
Temperature: -15°C to +60°C
Ø metric : 8 mm to 12 mm
Threads: BSPP

Pneumatic Sensor Fittings

(P. 4-50)



Function: pneumatic or electric output signal, detects end of cylinder rod stroke
Materials: polymer, treated metal
Pressure: 3 to 8 bar
Temperature: -15°C to +60°C
Ø metric: 4 mm
Threads: BSPP, metric

Function Fittings

Pressure Regulators/Pressure Reducers (P. 4-52)



Function: limits the maximum pressure delivered to pneumatic equipment

Materials: polymer, treated metal

Pressure: 16 bar (upstream), 8 bar (downstream)

Temperature: -15°C to +70°C

Ø metric: 4 mm to 10 mm

Threads: BSPP

Snap Connectors (P. 4-56)



Function: isolates a circuit without venting the whole system

Materials: polymer, nickel-plated brass

Pressure: 10 bar

Temperature: -20°C to +80°C

DN : 5 mm to 7 mm

Threads: BSPP

Manually-Operated Valves (P. 4-58)



Function: opens/closes a circuit, with or without venting

Materials: polymer, nickel-plated brass, aluminium

Pressure: 16 bar, 10 bar

Temperature: -10°C to +80°C

Ø metric: 4 mm to 10 mm

Threads: BSPP, metric

Metal Quick Exhaust Valves (P. 4-60)



Function: increases the return speed of the cylinder

Materials: nickel-plated brass, aluminium, stainless steel

Pressure: 10 bar

Temperature: -20°C to +70°C

Threads: BSPP, BSPT, metric

Silencers (P. 4-62)



Function: reduces noise levels

Materials: sintered bronze, polyethylene, stainless steel, nickel-plated brass

Pressure: 12 bar

Temperature: -20°C to +180°C







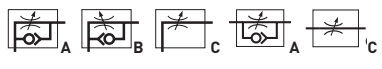
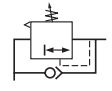
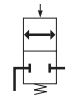

Ø metric: 4 mm to 12 mm

Threads: BSPP, metric, NPT

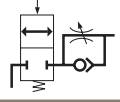
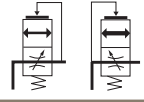
Selecting Your Function Fitting

Protect Your System	Blocking Fittings	Maintain the load following an emergency stop of a pneumatic system.	Models 7880 - 7881 - 7883 - 7885 7886
	Soft Start Fittings	Increase the pressure gradually in order to protect it from potentially damaging shock when a pneumatic system is restarted.	Models 7860 - 7861 - 7870 - 7871
	Non-Return Valves	Allow compressed air to flow in one direction, and prevent it from flowing in the other. If the supply is accidentally shut off, the air can only escape in one direction.	Models 4890 - 4891 - 4892 - 4895 7930 - 7931 - 7932 - 7984 7985 - 7992 - 7994 - 7995 7996
	Piloted Non-Return Valves	Incorporate 3 functions into one product to protect your system: piloted non-return valve, flow control regulator and manual vent.	Models 7892 - 7894
Detect End of Cylinder Rod Stroke	Pneumatic Sensor Fittings	Detect the back pressure drop at the end of stroke to produce a signal (pneumatic or electronic) to allow reciprocation.	Models 7818 - 7828
Control and Improve the Performance of Your System	Pressure Regulators	Regulate and stabilise the pressure at a maximum determined value whatever the upstream pressure.	Models 7300
	Pressure Reducer Fittings	Reduce the pressure consumed in one section of the machine in order to save energy.	Models 7316 - 7318 - 7416 - 7471
	Quick Exhaust Valves	Increase the return speed of the cylinder by discharging the exhaust directly to atmosphere.	Models 7899 - 7970 - 7971
	Silencers	Reduce the noise levels whilst air is vented from a compressed air system.	Models 0670 - 0671 - 0672 - 0673 0674 - 0675 - 0676 - 0677
Working on Your System	Snap Fittings	Allow a circuit to be isolated without fully venting the system.	Models 7921 - 7926 - 7960 - 7961
	Manually-Operated Valves	Allow for repeated venting by simply moving the valve sleeve or the manually-operated valve lever.	Models 0669 - 7800 - 7801 - 7802

Symbols for Function Fittings

<p>Regulating air flow</p> 	<p>Regulating pressure by stabilising at a required value</p> 
<p>Blocking air circulation</p> 	<p>Reducing pressure supply</p> 
<p>Blocking and regulating air flow</p> 	<p>Progressive pressurising of circuits</p> 
<p>Controlling allows the passage of fluid in one direction and prevents it in the other</p> 	<p>Isolating a circuit without venting the entire system</p> 
<p>Exhausting system and controlling pneumatic circuit supply</p> 	<p>Regulating, blocking and venting to protect the system and individuals</p> 
<p>Detecting pressure drop</p> 	

Selecting Your Flow Control Regulator

The comprehensive range of Parker Legris flow control regulators provides a solution for all flow regulation functions in a pneumatic system.

Select the model suited to your application according to:

5 Key Requirements

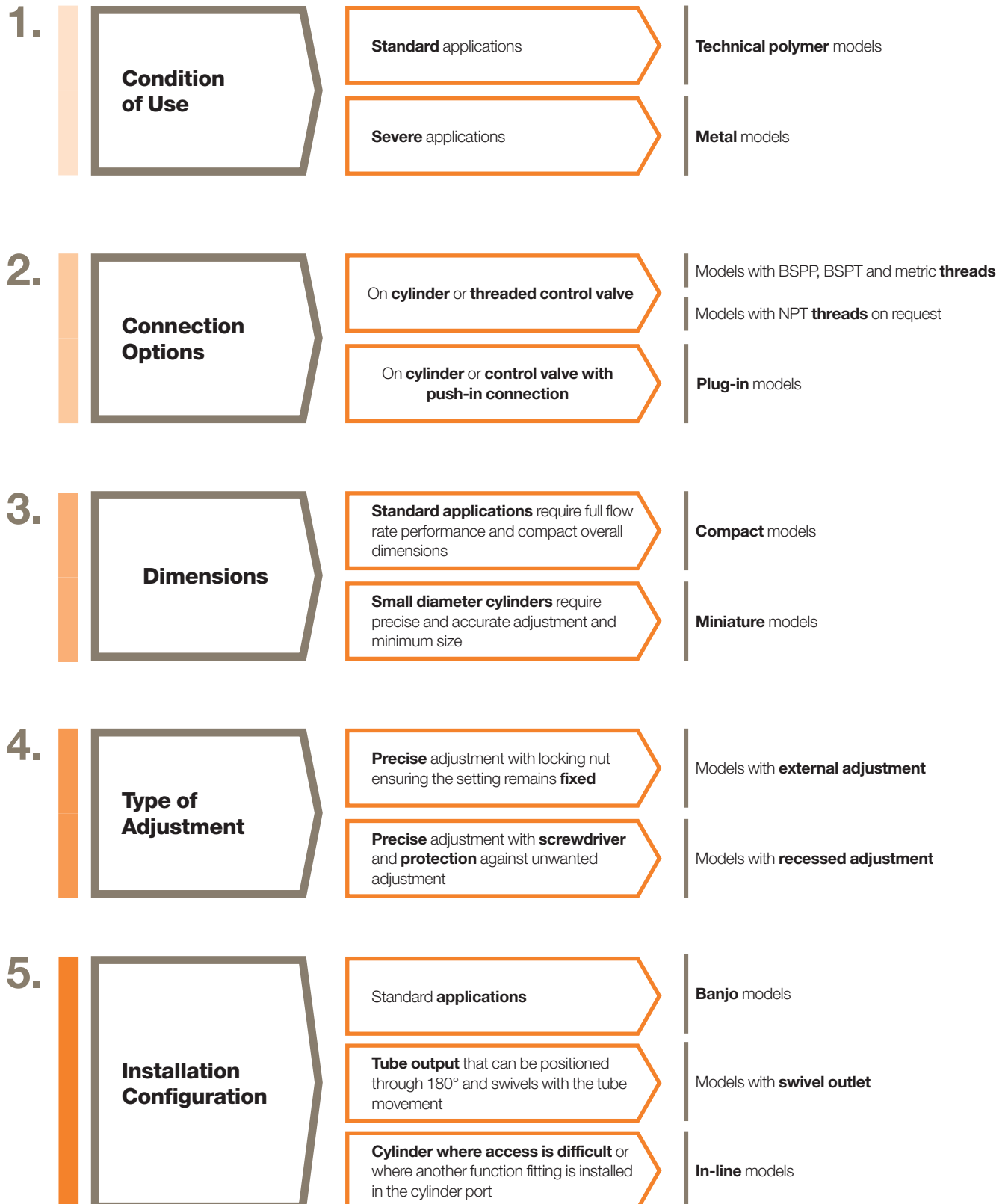

Flow Control Regulator Range

Technical Polymer Version, BSPP and Metric

Recessed Adjustment

7010
7011
7012
Push-In
Page 4-10



External Adjustment

7060
7061
7062
Compact
Push-In
Page 4-11/12



7660
7662
7669
Miniature
Push-In
Page 4-13/14



Swivel Outlet

7040
7041
Compact
Push-In
Page 4-14



7640
7649
Miniature
Push-In
Page 4-15



In-Line

7770
7772
Push-In
Page 4-16



7776
Bulkhead
Push-In
Page 4-16



7771
Threaded
Page 4-16



7020
Straight
Push-In
Page 4-17



7000
Page 4-16



Plug-In

7030
7031
Compact
Push-In
Page 4-18



7630
7631
Miniature
Push-In
Page 4-18



Technical Polymer Version, BSPT

External Adjustment

7065
7066
7067
Compact
Push-In
Page 4-11/12



7665
7668
Miniature
Push-In
Page 4-13



Swivel Outlet and External Adjustment

7045
Compact
Push-In
Page 4-14



7645
Miniature
Push-In
Page 4-15



Brass, Nickel-Plated Brass and Aluminium Versions, BSPP and Metric

Recessed Adjustment

7130
Push-In
Page 4-19



7140
Threaded
Page 4-19



7160
Compression
Page 4-19



In-Line

7170
Bulkhead
Threaded
Page 4-21



External Adjustment

7762
Threaded
Page 4-21



7100
7101
Compact
Push-In
Page 4-20



7680
Compact
Push-In
Page 4-20



7180
Miniature
Push-In
Page 4-20



7110
7111
Compact
Threaded
Page 4-20/21



7190
Miniature
Threaded
Page 4-21



Stainless Steel Versions

7810
7812
Threaded
Page 4-23



7820
7822
Threaded
Page 4-23



Flow Control Regulators

Parker Legris flow control regulators with polymer, nickel-plated brass or aluminium bodies, external or recessed adjustment screws, offer **precise adjustment, accuracy** and **compactness** providing the solution for all applications.

Product Advantages

Improved Productivity

- Higher maximum flow than standard regulators
- Full flow with minimum pressure drop (model 7060)
- Optimal control of the cylinder rod speed
- 100% leak-tested in production
- Date coding to guarantee quality and traceability
- Reduce compressed air and energy consumption

Accuracy & Performance

- Precise adjustment for accurate flow regulation from initial to maximum opening
- Constant cylinder rod displacement speed
- Long-term stability of flow
- Reduced weight (polymer version)
- Mechanical strength and corrosion resistance with nickel-plated brass version

Ergonomics & Large Range

- External adjustment screw: easy to adjust without tooling and lockable
- Recessed adjustment screw: more compact and protects the adjustment mechanism
- Uni-directional: exhaust or inlet
- Bi-directional: adjustment of air flow in both directions
- 360° positioning
- NPT version on request



Applications

- Pneumatics
- Robotics
- Semi-Conductors
- Textile
- Automotive Process
- Packaging

Technical Characteristics

Compatible Fluids	Compressed air Other fluids: contact us
Working Pressure	1 to 10 bar
Working Temperature	0°C to +70°C

Max. Tightening Torques (external adjustment screw)	Threads	M3 x0.5	M5 x0.8	G1/8	G1/4	G3/8	G1/2
	daN.m	0.06	0.16	0.8	1.2	3	3.5
Max. Tightening Torques (recessed adjustment screw)	Threads	–	M5 x0.8	G1/8	G1/4	G3/8	G1/2
	daN.m	–	0.1	0.4	0.5	0.6	0.7

You will find all the flow rate characteristic curves (to 6 bar) for flow control regulators at the end of the chapter.

Component Materials

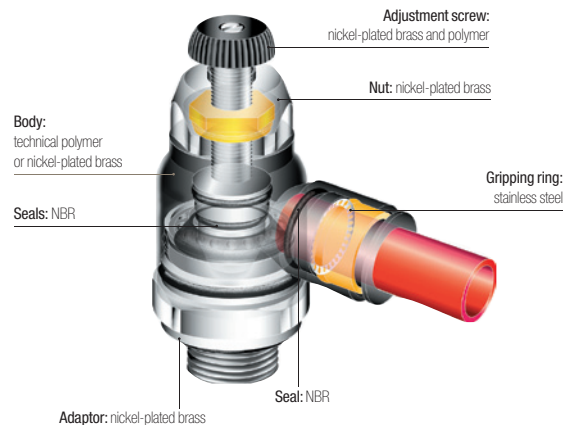

Silicone-free

Flow Control Regulators

Operation

Parker Legris offers both uni-directional and bi-directional flow control regulators.

The uni-directional models control the flow of air in one direction through an adjustable restrictor, while allowing full flow in the opposite direction.

The bi-directional models control the flow of air in both directions.

A more precise and constant flow regulation is obtained when the regulator is fitted directly onto the cylinder.

Models with Recessed Adjustment

Uni-Directional (Exhaust Version)

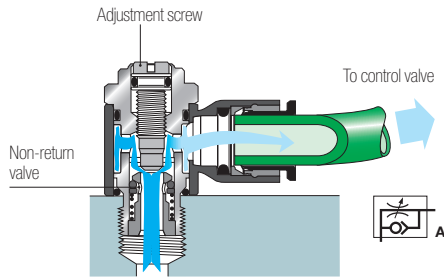

Uni-Directional (Supply Version)

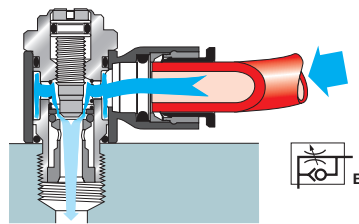

Bi-Directional Version

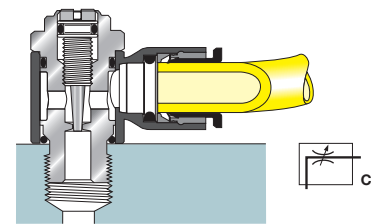

Models with External Adjustment

Uni-Directional (Exhaust Version)

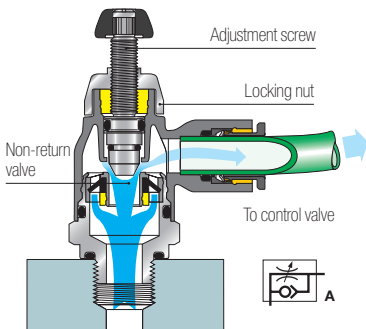

Uni-Directional (Supply Version)

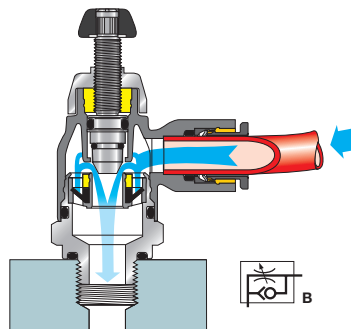

Bi-Directional Version

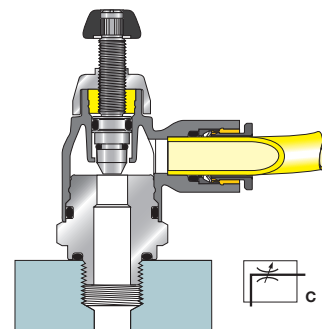

In-Line Models

Uni-Directional Version

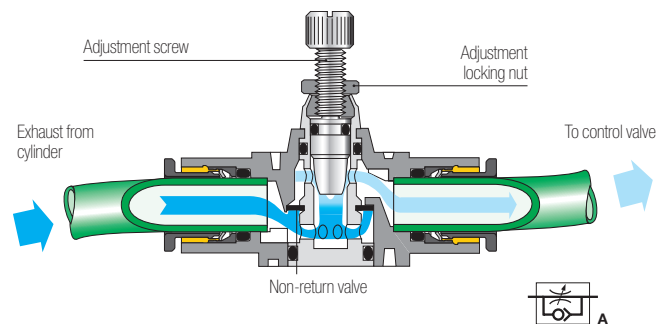

Bi-Directional Version

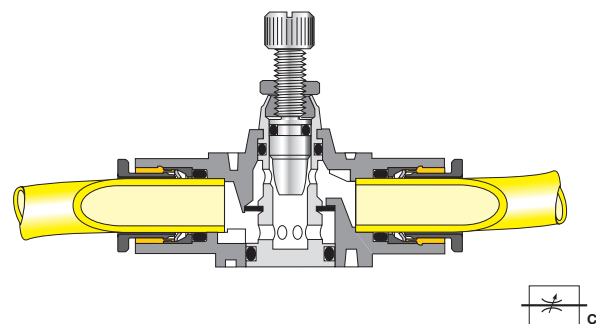

For instant visual identification, each Parker Legris flow control regulator version is identified by the related pneumatic symbol and by a letter:

- uni-directional regulation on exhaust: letter A
- uni-directional regulation on supply: letter B
- bi-directional regulation: letter C

Regulators with Recessed Adjustment

7010

Flow Regulator with Recessed Adjustment Screw Exhaust, Male BSPP and Metric Thread



Technical polymer, nickel-plated brass, NBR

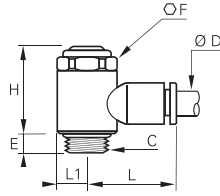

ØD	C		E	F	H	L	L1	kg
4	M5x0.8	7010 04 19	4	8	17.5	17	5	0.006
	G1/8	7010 04 10	5	13	25	19	7	0.018
6	M5x0.8	7010 06 19	4	8	17.5	19	5	0.006
	G1/8	7010 06 10	5	13	25	21	7	0.018
8	G1/4	7010 08 13	8	17	26.5	22	9.5	0.034
	G1/8	7010 08 10	5	13	25	26	7	0.019
10	G1/4	7010 10 13	8	17	26.5	29	9.5	0.035
	G3/8	7010 10 17	7.5	20	37.5	29	11	0.068
12	G1/4	7010 12 13	8	17	26.5	29	9.5	0.035
	G3/8	7010 12 17	7.5	20	37.5	31	11	0.067
	G1/2	7010 12 21	8	23	43	37	13.5	0.118
	G3/8	7010 12 17	7.5	20	37.5	34.5	11	0.069
	G1/2	7010 12 21	8	23	43	37	13.5	0.108

7011

Flow Regulator with Recessed Adjustment Screw Supply, Male BSPP and Metric Thread



Technical polymer, nickel-plated brass, NBR

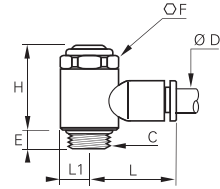

ØD	C		E	F	H	L	L1	kg
4	M5x0.8	7011 04 19	4	8	17.5	17	5	0.006
	G1/8	7011 04 10	5	13	25	19	7	0.018
6	M5x0.8	7011 06 19	4	8	17.5	19	5	0.006
	G1/8	7011 06 10	5	13	25	21	7	0.018
8	G1/4	7011 08 13	8	17	26.5	22	9.5	0.034
	G1/8	7011 08 10	5	13	25	26	7	0.019
10	G1/4	7011 10 13	8	17	26.5	29	9.5	0.036
	G3/8	7011 10 17	7.5	20	37.5	29	11	0.067
	G1/4	7011 10 13	8	17	26.5	29	9.5	0.036
	G3/8	7011 10 17	7.5	20	37.5	31	11	0.068

7012

Bi-Directional Flow Regulator with Recessed Adjustment Screw, Male BSPP and Metric Thread



Technical polymer, nickel-plated brass, NBR

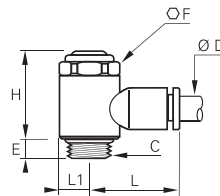

ØD	C		E	F	H	L	L1	kg
4	M5x0.8	7012 04 19	4	8	17.5	17	5	0.006
	G1/8	7012 04 10	5	13	25	19	7	0.018
6	M5x0.8	7012 06 19	4	8	17.5	19	5	0.007
	G1/8	7012 06 10	5	13	25	21	7	0.019
8	G1/4	7012 08 13	8	17	26.5	22	9.5	0.036
	G1/8	7012 08 10	5	13	25	26	7	0.020
10	G1/4	7012 10 13	8	17	26.5	27	9.5	0.036
	G3/8	7012 10 17	7.5	20	37.5	29	11	0.070

Each pneumatic function fitting is identified by:

- the item type
- the tube outside diameter
- the thread or 2nd tube outside diameter

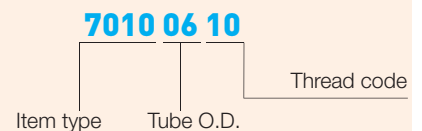

Compact Regulators with External Adjustment

7060 Compact Flow Regulator Exhaust, Male BSPP Thread



Technical polymer, nickel-plated brass, NBR

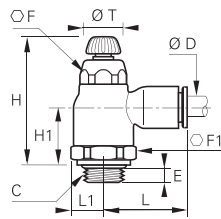

ØD	C		E	F	F1	H	H _{max}	H1	L	L1	ØT	kg
4	G1/8	7060 04 10	5	10	16	38	44	16	22	9	10	0.020
	G1/8	7060 06 10	5	10	16	38	44	16	22	9	10	0.020
6	G1/4	7060 06 13	5.5	10	16	36.5	42.5	15	22	9	10	0.020
	G1/8	7060 08 10	4.5	14	19	41.5	48	18	28	10.5	14	0.033
8	G1/4	7060 08 13	5.5	14	19	41.5	48	18.5	28	10.5	14	0.034
	G3/8	7060 08 17	5.5	14	19	41.5	48	17	28	11	14	0.034
10	G1/4	7060 10 13	5.5	17	23	45.5	53.5	20	31.5	12.5	17	0.053
	G3/8	7060 10 17	5.5	17	23	45.5	54	20	31.5	12.5	17	0.054
12	G3/8	7060 12 17	5.5	17	23	45.5	54	20	35	12.5	17	0.060
	G1/2	7060 12 21	7.5	17	24	45.5	54	20	35	13	17	0.058

7065 Compact Flow Regulator Exhaust, Male BSPT Thread



Technical polymer, nickel-plated brass, NBR

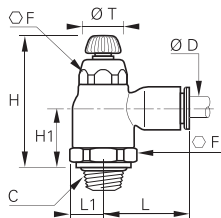

ØD	C		F	F1	H _{min}	H _{max}	H1	L	L1	ØT	kg
6	R1/8	7065 06 10	10	16	36.5	42.5	15	22	8	10	0.021
	R1/8	7065 08 10	14	19	40	45	16.5	28	10.5	14	0.034
8	R1/4	7065 08 13	14	19	40	45	16.5	28	10.5	14	0.036
	R1/4	7065 10 13	17	23	43.5	51.5	18	31.5	12.5	17	0.053
10	R3/8	7065 10 17	17	23	43.5	51.5	18	31.5	12.5	17	0.055
	R1/2	7065 10 21	17	23	43.5	51.5	18	31.5	12.5	17	0.059
12	R1/4	7065 12 13	17	23	43.5	51.5	18	35	12.5	17	0.056
	R3/8	7065 12 17	17	23	43.5	51.5	18	35	12.5	17	0.059
	R1/2	7065 12 21	17	23	43.5	51.5	18	35	12.5	17	0.064

Pre-coated thread

7061 Compact Flow Regulator Supply, Male BSPP Thread



Technical polymer, nickel-plated brass, NBR

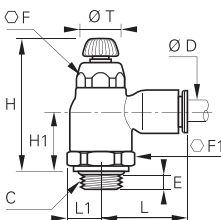

ØD	C		E	F	F1	H	H _{max}	H1	L	L1	ØT	kg
4	G1/8	7061 04 10	5	10	16	38	44	16	22	9	10	0.020
	G1/8	7061 06 10	5	10	16	38	44	16	22	9	10	0.020
6	G1/4	7061 06 13	5.5	10	16	36.5	42.5	15	22	9	10	0.021
	G1/8	7061 08 10	4.5	14	19	41.5	48	18	28	10.5	14	0.033
8	G1/4	7061 08 13	5.5	14	19	41.5	48	18.5	28	10.5	14	0.034
	G3/8	7061 08 17	5.5	14	23	41.5	48	17	28	11	14	0.033
10	G1/4	7061 10 13	5.5	17	23	45.5	53.5	20	31.5	12.5	17	0.053
	G3/8	7061 10 17	5.5	17	23	45.5	54	20	31.5	12.5	17	0.054
12	G1/2	7061 12 21	7.5	17	24	45.5	54	20	35	13	17	0.060

7066 Compact Flow Regulator Supply, Male BSPT Thread



Technical polymer, nickel-plated brass, NBR

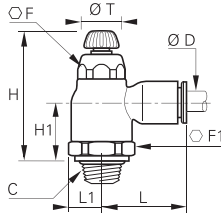

ØD	C		F	F1	H _{min}	H _{max}	H1	L	L1	ØT	kg
	R1/4	7066 10 13	17	23	43.5	51.5	18	31.5	12.5	17	0.020
10	R3/8	7066 10 17	17	23	43.5	51.5	18	31.5	12.5	17	0.020
	R1/2	7066 10 21	17	23	43.5	51.5	18	31.5	12.5	17	0.059
12	R1/4	7066 12 13	17	23	43.5	51.5	18	35	12.5	17	0.056
	R3/8	7066 12 17	17	23	43.5	51.5	18	35	12.5	17	0.059
	R1/2	7066 12 21	17	23	43.5	51.5	18	35	12.5	17	0.064

Pre-coated thread

Compact Regulators with External Adjustment

7062 Bi-Directional Compact Flow Regulator, Male BSPP Thread



Technical polymer, nickel-plated brass, NBR

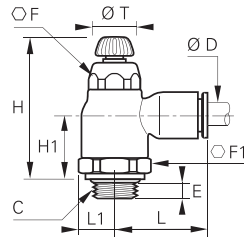

ØD	C		E	F	F1	H	H _{max}	H1	L	L1	ØT	kg
4	G1/8	7062 04 10	5	10	16	38	44	16	22	9	10	0.025
6	G1/8	7062 06 10	5	10	16	38	44	16	22	9	10	0.025
	G1/4	7062 06 13	5.5	10	16	36.5	42.5	15	22	9	10	0.025
8	G1/8	7062 08 10	4.5	14	19	41.5	48	18	28	10.5	14	0.043
	G3/8	7062 08 17	5.5	14	19	41.5	48	17	28	11	14	0.042

7067 Bi-Directional Compact Flow Regulator, Male BSPT Thread



Technical polymer, nickel-plated brass, NBR

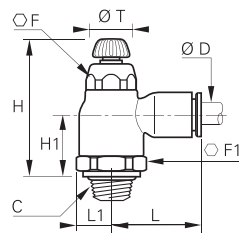

ØD	C		F	F1	H _{min}	H _{max}	H1	L	L1	ØT	kg
4	R1/8	7067 04 10	10	16	36.5	42.5	14.7	22	9	10	0.025
6	R1/8	7067 06 10	10	16	36.5	42.5	14.7	22	9	10	0.010
	R1/4	7067 06 13	10	16	36.5	42.5	14.7	22	9	10	0.014
8	R1/8	7067 08 10	14	19	40	45	16.5	28	10.5	14	0.034
	R1/4	7067 08 13	14	19	40	45	16.5	28	10.5	14	0.036
	R3/8	7067 08 17	14	19	40	45	16.5	28	11	14	0.042

Pre-coated thread

Miniature Regulators with External Adjustment

7660

Miniature Flow Regulator Exhaust, Male BSPP and Metric Thread



Technical polymer, nickel-plated brass, NBR

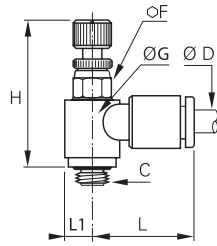

ØD	C		F	G	H min	H max	L	L1	kg
3	M3x0.5	7660 03 09	6	9	23.5	26	17	4.5	0.007
	M5x0.8	7660 03 19	6	9	23.5	26	17	4.5	0.006
4	M3x0.5	7660 04 09	6	9	23.5	26	16.5	4.5	0.007
	M5x0.8	7660 04 19	6	9	23.5	26	17	4.5	0.006
6	G1/8	7660 06 10	7	11.5	27	29.5	18	6	0.012
	M5x0.8	7660 06 19	6	9	23.5	26	18	4.5	0.007
8	G1/4	7660 08 13	8	12	30	32.5	19	6	0.019
	G1/8	7660 08 10	13	14	26.5	31	26	7	0.021
	G3/8	7660 08 17	20	23	36	42	29	11.5	0.062

7665

Miniature Flow Regulator Exhaust, Male BSPT Thread



Technical polymer, nickel-plated brass, NBR

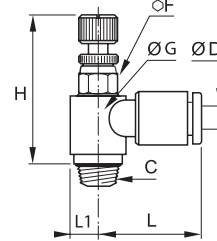

ØD	C		F	G	H min	H max	L	L1	kg
4	R1/8	7665 04 10	7	11.5	25	27.5	18	6	0.012
	R1/8	7665 06 10	7	11.5	25	27.5	18.5	6	0.012
6	R1/4	7665 06 13	8	13.5	27.5	30	19	7	0.019
	R3/8	7665 06 17	17	13.5	31.5	34	19	7	0.025
8	R1/8	7665 08 10	13	14	24	28.5	26	7	0.021
	R3/8	7665 08 17	16	19	25	29	27.5	9.5	0.033

Pre-coated thread

7669

Miniature Flow Regulator Supply, Male BSPP and Metric Thread



Technical polymer, nickel-plated brass, NBR

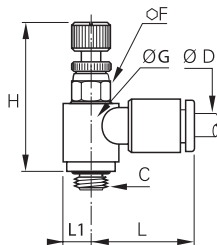

ØD	C		F	G	H min	H max	L	L1	kg
3	M3x0.5	7669 03 09	6	9	23.5	26	17	4.5	0.008
	M5x0.8	7669 03 19	6	9	23.5	26	17	4.5	0.007
4	M5x0.8	7669 04 19	6	9	23.5	26	17	4.5	0.006
	G1/8	7669 04 10	7	11.5	27	29.5	18	6	0.012
6	M5x0.8	7669 06 19	6	9	23.5	26	18	4.5	0.007
	G1/8	7669 06 10	7	11.5	27	29.5	18.5	6	0.013
	G1/4	7669 06 13	8	12	30	32.5	19	6	0.019
8	G1/8	7669 08 10	13	14	26.5	31	26	7	0.021
	G1/4	7669 08 13	16	19	29	34	27.5	9.5	0.033
	G3/8	7669 08 17	20	23	36	42	29	11.5	0.063

7668

Miniature Flow Regulator Supply, Male BSPT Thread



Technical polymer, nickel-plated brass, NBR

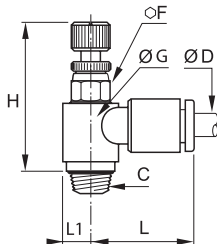

ØD	C		F	G	H min	H max	L	L1	kg
4	R1/8	7668 04 10	7	11.5	25	27.5	18	6	0.011
	R1/8	7668 06 10	7	11.5	25	27.5	18.5	6	0.012
6	R1/4	7668 06 13	8	13.5	27.5	30	19	7	0.019
	R1/8	7668 08 10	13	14	24	28.5	26	7	0.020
8	R1/4	7668 08 13	16	19	25	29	27.5	9.5	0.032
	R3/8	7668 08 17	20	23	30	36	29	11.5	0.061

Pre-coated thread

Regulators with External Adjustment

7662 Bi-Directional Miniature Flow Regulator, Male BSPP and Metric Thread



Technical polymer, nickel-plated brass, NBR

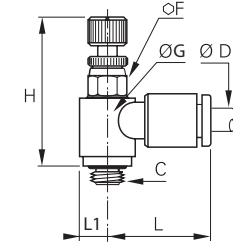

ØD	C		F	G	H _{min}	H _{max}	L	L1	kg
4	M5x0.8	7662 04 19	6	9	23.5	26	17	4.5	0.007
	G1/8	7662 04 10	7	11.5	27	29.5	18	6	0.013
6	M5x0.8	7662 06 19	6	9	23.5	26	18	4.5	0.010
	G1/8	7662 06 10	7	11.5	27	29.5	18.5	6	0.013
	G1/4	7662 06 13	8	12	30	32.5	19	6	0.019

7040 Compact Flow Regulator Swivel Outlet Exhaust, Male BSPP Thread



Technical polymer, nickel-plated brass, NBR

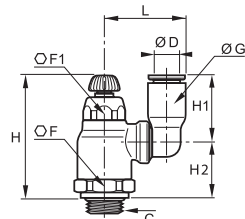

ØD	C		F	F1	G	H _{min}	H _{max}	H1	H2	L	kg
6	G1/8	7040 06 10	16	10	10.5	38	44	16	18	23.5	0.024
	G1/4	7040 06 13	16	10	10.5	36.5	42.5	16	16.5	23.5	0.025
8	G1/8	7040 08 10	19	14	13.5	41.5	48	23	19	28	0.037
	G1/4	7040 08 13	19	14	13.5	41.5	48	23	19.5	28	0.039
10	G3/8	7040 08 17	19	14	13.5	41.5	48	23	17.5	28	0.020
	G1/4	7040 10 13	23	17	16	45.5	53.5	26.5	21	35	0.051
12	G3/8	7040 10 17	23	17	16	45.5	54	26.5	21.5	35	0.063
	G1/2	7040 12 21	23	17	19	45.5	54	30.5	21.5	38	0.066
	G1/2	7040 12 21	24	17	19	45.5	54	30.5	21	38	0.071

7045 Compact Flow Regulator Swivel Outlet Exhaust, Male BSPT Thread



Technical polymer, nickel-plated brass, NBR

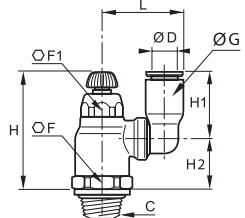

ØD	C		F	F1	G	H _{min}	H _{max}	H1	H2	L	kg
6	R1/4	7045 06 13	16	10	10.5	36.5	42.5	16	16.5	23.5	0.030
	R1/8	7045 08 10	19	14	13.5	40	46	23	17	28	0.014
8	R1/4	7045 08 13	19	14	13.5	40	46	23	17	28	0.043
	R3/8	7045 08 17	19	14	13.5	40	46	23	17	28	0.044
10	R1/4	7045 10 13	23	17	16	43.5	51.5	26.5	19	35	0.062
	R3/8	7045 10 17	23	17	16	43.5	51.5	26.5	19	35	0.065
12	R3/8	7045 12 17	23	17	19	43.5	51.5	31	19	38	0.065
	R1/2	7045 12 21	23	17	19	43.5	51.5	31	19	38	0.070

Pre-coated thread

7041 Compact Flow Regulator Swivel Outlet Supply, Male BSPP Thread



Technical polymer, nickel-plated brass, NBR

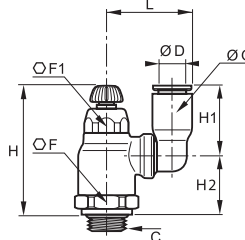

ØD	C		F	F1	G	H _{min}	H _{max}	H1	H2	L	kg
6	G1/4	7041 06 13	16	10	10.5	36.5	42.5	16	16.5	23.5	0.024
8	G1/8	7041 08 10	19	14	13.5	41.5	48	23	19	28	0.037
	G1/4	7041 08 13	19	14	13.5	41.5	48	23	19.5	28	0.039

Miniature Regulators with Swivel Outlet and External Adjustment

7640

Miniature Swivel Outlet Flow Regulator Exhaust, Male BSPP and Metric Thread



Technical polymer, nickel-plated brass, NBR

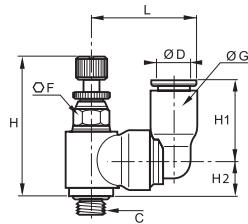

ØD	C		F	G	H _{min}	H _{max}	H1	H2	L	kg
4	M5x0.8	7640 04 19	6	8.5	23.5	26	14	6.5	19.5	0.011
	G1/8	7640 04 10	7	8.5	27	29.5	14	8	19.5	0.015
6	M5x0.8	7640 06 19	6	10.5	23.5	26	16	6.5	21	0.001
	G1/8	7640 06 10	7	10.5	27	29.5	16	8	20.5	0.015

7645

Miniature Swivel Outlet Flow Regulator Exhaust, Male BSPT Thread



Technical polymer, nickel-plated brass, NBR

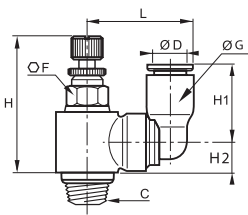

ØD	C		F	G	H _{min}	H _{max}	H1	H2	J	L	kg
4	R1/8	7645 04 10	7	8.5	25	27.5	14	6	11.5	19.5	0.014
6	R1/8	7645 06 10	7	10.5	25	27.5	16	6	11.5	21.5	0.012

Pre-coated thread

7649

Miniature Swivel Outlet Flow Regulator Supply, Male BSPP and Metric Thread



Technical polymer, nickel-plated brass, NBR

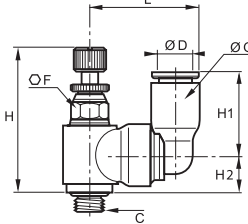

ØD	C		F	G	H _{min}	H _{max}	H1	H2	L	kg
4	M5x0.8	7649 04 19	6	8.5	23.5	26	14	6.5	19	0.015
	G1/8	7649 04 10	7	8.5	27	29.5	14	8.5	19.5	0.014
6	M5x0.8	7649 06 19	6	10.5	23.5	26	16	6.5	21	0.008
	G1/8	7649 06 10	7	10.5	27	29.5	16	8.5	21.5	0.015

Associated Products

All our flow control regulators are compatible with the range of polyamide and polyurethane tubing shown in Chapter 3.

In-Line Regulators with External Adjustment

7770 In-Line One-Way Flow Regulator



Technical polymer, NBR

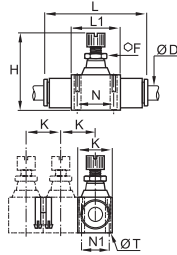

ØD		F	H _{min}	H _{max}	K	L	L1	N	N1	ØT	kg
4	7770 04 00	5	29.5	33.5	12	36	15	11	8	2.2	0.010
6	7770 06 00	8	40.5	44.5	17	51	23	17	11	3.2	0.028
8	7770 08 00	11	46.5	52.5	18.5	58	26	20	12.5	3.2	0.048
10	7770 10 00	14	53	61	24	73	33	26	16	4.2	0.097
12	7770 12 00	14	59	67.5	28	85	35	27.5	20	4.2	0.132

7772 Bi-Directional In-Line Flow Regulator



Technical polymer, NBR

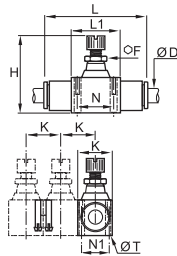

ØD		F	H _{min}	H _{max}	K	L	L1	N	N1	ØT	kg
4	7772 04 00	5	29.5	33.5	12	36	15	11	8	2.2	0.011
6	7772 06 00	8	40	44.5	17	51	23	17	11	3.2	0.032
8	7772 08 00	11	46.5	52.5	18.5	58	26	20	12.5	3.2	0.054

7776 Panel-Mountable In-Line One-Way Flow Regulator

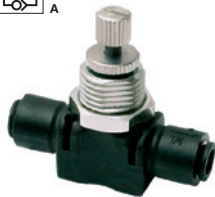

Technical polymer, NBR

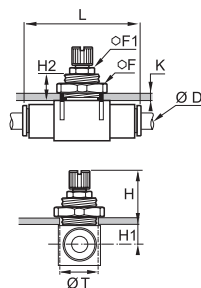

ØD		F	F1	H	H _{max}	H1	H2	K	L	ØT	kg
4	7776 04 00*	14	-	21.5	25.5	6.5	11	6	36	10.5	0.017
6	7776 06 00*	19	-	27.5	32.5	7.5	13.5	7	51	16.5	0.042
8	7776 08 00	24	11	28.5	34.5	9	13.5	7	58	18.5	0.069
10	7776 10 00	30	14	29.5	38.5	11.5	13.5	7	73	24.5	0.136
12	7776 12 00	32	14	32	42	12.5	15.5	8	85	27.5	0.185

*Ultrafine adjustment

7771 In-Line One-Way Flow Regulator, Female BSPP Thread



Technical polymer, nickel-plated brass, NBR

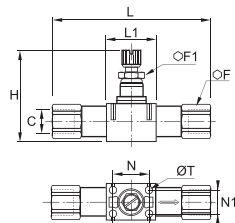

C		F	F1	H _{min}	H _{max}	L	L1	N	N1	ØT	kg
G1/8	7771 10 10	13	8	39.5	44.5	68.5	23	17	11	3.2	0.043
G1/4	7771 13 13	16	11	44	50	83	26	20	12.5	3.2	0.103
G3/8	7771 17 17	19	14	52	61	97	33	26	16	4.2	0.160
G1/2	7771 21 21	24	14	57.5	67.5	121	35	27.5	20	4.2	0.260

7000 Joining Clips



Technical polymer



ØD		kg
4	7000 00 05	0,004
6	7000 00 05	0,004
8	7000 00 05	0,004
10	7000 00 06	0,009
12	7000 00 06	0,009

In-Line Regulators with External Adjustment

7020

Straight Flow Regulator Exhaust, Male BSPP Thread



Technical polymer, nickel-plated brass, NBR

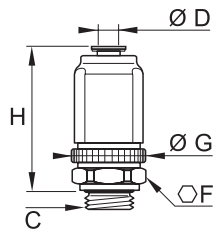

ØD	C		F	G	H min	H max	kg
4	G1/8	7020 04 10	18	21.5	38.5	44	0.062
6	G1/8	7020 06 10	18	21.5	38.5	44	0.058
	G1/4	7020 06 13	18	21.5	38.5	44	0.059
8	G1/8	7020 08 10	24	27	46.5	52.5	0.110
	G1/4	7020 08 13	24	27	46.5	52.5	0.112

Plug-In Regulators with External Adjustment

7030

Compact Plug-In Flow Regulator, Exhaust



Technical polymer, nickel-plated brass, NBR

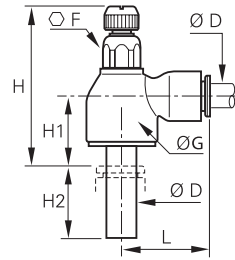

ØD		F	G	H min	H max	H1	H2	L	kg
6	7030 06 00	10	16	35	41	14	17	22	0.013
8	7030 08 00	14	19	39.5	46.5	16	21.5	28	0.022
10	7030 10 00	17	23	43.5	51.5	17.5	24.5	31.5	0.030
12	7030 12 00	17	23	43	51	17	27	35	0.044

7031

Compact Plug-In Flow Regulator, Supply



Technical polymer, nickel-plated brass, NBR

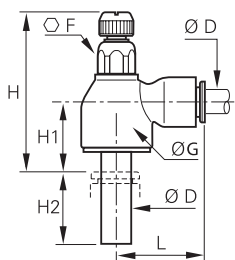

ØD		F	G	H min	H max	H1	H2	L	kg
6	7031 06 00	10	16	35	41	14	17	22	0.013
8	7031 08 00	14	19	39.5	46.5	16	21.5	28	0.035
10	7031 10 00	17	23	43.5	51.5	17.5	24.5	31.5	0.010
12	7031 12 00	17	23	43	51	17	27	35	0.044

7630

Miniature Plug-In Flow Regulator, Exhaust



Technical polymer, nickel-plated brass, NBR

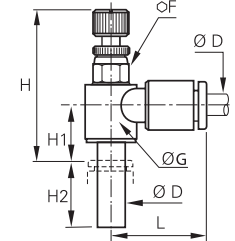

ØD		F	G	H min	H max	H1	H2	L	kg
4	7630 04 00	6	9	25.5	28	9.5	15.5	17	0.007
6	7630 06 00	7	11.5	27.5	29	10.5	17	18.5	0.012

7631

Miniature Plug-In Flow Regulator, Supply



Technical polymer, nickel-plated brass, NBR

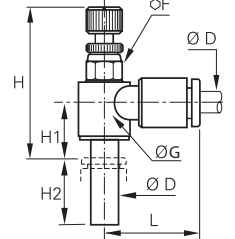

ØD		F	G	H min	H max	H1	H2	L	kg
4	7631 04 00	6	9	25.5	28	9.5	15.5	17	0.007
6	7631 06 00	7	11.5	27.5	29	10.5	17	18.5	0.011

Metal Regulators with Recessed Adjustment

7130 Flow Regulator, Exhaust, Male BSPP and Metric Thread



Nickel-plated brass, NBR

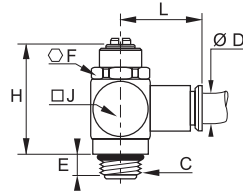

ØD	C		E	F	H	J	L	kg
4	M5x0.8	7130 04 19	4	8	17	9	19	0.015
	G1/8	7130 04 10	5	13	34	15	20	0.037
6	M5x0.8	7130 06 19	4	8	17	9	24	0.013
	G1/8	7130 06 10	5	13	34	15	22	0.038
8	G1/4	7130 08 13	8	17	39	18	24	0.062
	G1/8	7130 08 10	5	13	34	15	25	0.042
8	G1/4	7130 08 13	8	17	39	18	28	0.066
	G3/8	7130 08 17	7	20	47	21.5	29	0.109
10	G1/4	7130 10 13	8	17	39	18	30	0.075
	G3/8	7130 10 17	7	20	47	21.5	32	0.120
10	G1/2	7130 10 21	8	23	61	28	34	0.222
	G3/8	7130 12 17	7	20	47	22	36	0.064
12	G1/2	7130 12 21	8	23	61	28	38	0.306

7140 Flow Regulator, Exhaust, Male/Female BSPP and Metric Thread



Nickel-plated brass, NBR

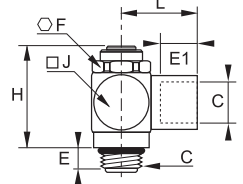

C		E	E1	F	H	J	L	kg
M5x0.8	7140 19 19	4	4	8	21	9	11	0.009
G1/8	7140 10 10	5	8	13	32	15	17	0.040
G1/4	7140 13 13	8	12	17	39	18	24	0.073
G3/8	7140 17 17	7	12	20	47	21.5	27	0.125
G1/2	7140 21 21	8	15	23	61	28	31	0.238

7160 Flow Regulator with Brass Compression Fitting, Exhaust, Male BSPP Thread



Nickel-plated brass, NBR

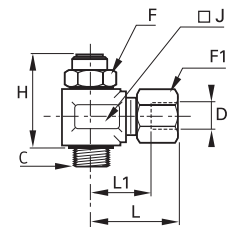

ØD	C		F	F1	H	J	L	L1	kg
4	G1/8	7160 04 10	13	10	26	17	25.5	14.5	0.049
	G1/8	7160 06 10	13	13	26	17	25.5	14.5	0.054
6	G1/4	7160 06 13	17	13	31.5	22	28.5	17.5	0.103
	G1/8	7160 08 10	13	14	26	17	29.5	15.5	0.055
8	G1/4	7160 08 13	17	14	31.5	22	31	17	0.103
	G1/4	7160 10 13	17	19	31.5	22	35	19	0.118
10	G3/8	7160 10 17	20	19	44.5	22	37.5	19	0.188
	G1/2	7160 10 21	23	19	50	27	37.5	19	0.202
12	G3/8	7160 12 17	20	22	44.5	22	38	21.5	0.200
	G1/2	7160 12 21	23	22	50	27	38	21.5	0.213

Metal Regulators with External Adjustment

7100 Compact Flow Regulator, Exhaust, Male BSPP Thread



Nickel-plated brass, NBR

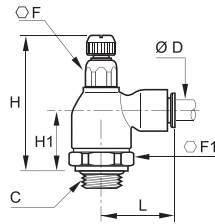

ØD	C		F	F1	H _{min}	H _{max}	H1	L	kg
4	G1/8	7100 04 10	10	19	47	53	23	21	0.078
	G1/8	7100 06 10	10	19	47	53	23	24.5	0.080
6	G1/4	7100 06 13	10	19	47.5	53	23.5	24.5	0.083
	G1/8	7100 08 10	14	19	50	55	24.5	29	0.097
8	G1/4	7100 08 13	14	19	50	56	25	29	0.100
	G3/8	7100 08 17	17	25	56	62	27	30.5	0.154
10	G1/4	7100 10 13	14	19	50	56	25	35	0.103
	G3/8	7100 10 17	17	25	56	62	27	35	0.157
12	G3/8	7100 12 17	17	25	56	62	27	38	0.198
	G1/2	7100 12 21	17	25	55	62	27	38	0.207
14	G1/2	7100 14 21	17	25	55	62	27	41	0.205

7101 Compact Flow Regulator, Supply, Male BSPP Thread



Nickel-plated brass, NBR

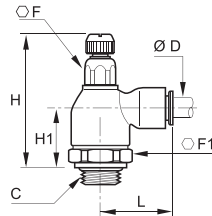

ØD	C		F	F1	H _{min}	H _{max}	H1	L	kg
4	G1/8	7101 04 10	10	19	47	53	23	21	0.096
	G1/8	7101 06 10	10	19	47	53	23	24.5	0.080
6	G1/4	7101 06 13	10	19	47.5	53	23.5	24.5	0.080
	G1/8	7101 08 10	14	19	50	55	24.5	29	0.097
8	G1/4	7101 08 13	14	19	50	56	25	29	0.100
	G3/8	7101 08 17	17	25	56	62	27	30.5	0.155

7680 Compact Flow Regulator, Male BSPP Thread



Nickel-plated brass, NBR

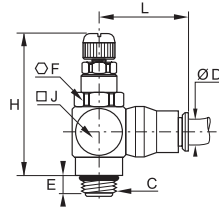

ØD	C		E	F	H _{min}	H _{max}	J	L	kg
6	G1/8	7680 06 10	5	13	39	44	7.5	24.5	0.045
	G1/8	7680 08 10	5	13	39	44	7.5	24.5	0.047
8	G1/4	7680 08 13	8	17	41	47	9	27	0.076
	G3/8	7680 10 17	7	20	50	60	11	34	0.133
12	G1/2	7680 12 21	8	23	65	77	14	36.5	0.165

7180 Miniature Flow Regulator Exhaust, Male BSPP and Metric Thread



Nickel-plated brass, NBR

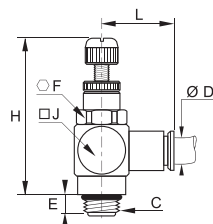

ØD	C		E	F	H _{min}	H _{max}	J	L	kg
4	M5x0.8	7180 04 19	4	8	24	29	10	19	0.012
	G1/8	7180 04 10	5	13	39	44	15	20	0.042
6	M5x0.8	7180 06 19	4	8	24	29	10	24	0.015
	G1/8	7180 06 10	5	13	39	44	15	22	0.043
8	G1/8	7180 08 10	5	13	39	44	15	26	0.049

7110 Compact Flow Regulator Exhaust, Male/Female BSPP Thread



Nickel-plated brass, NBR

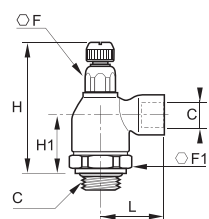

C		F	F1	H _{min}	H _{max}	H1	L	kg
G1/8	7110 10 10	10	19	47	52.5	23	22.5	0.079
G1/4	7110 13 13	14	19	50.5	55.5	25	32	0.108
G3/8	7110 17 17	17	25	56	62	27	34.5	0.212
G1/2	7110 21 21	17	25	55	62	27	37.5	0.192

Metal Regulators with External Adjustment

7111 Compact Flow Regulator Supply, Male/Female BSPP Thread



Nickel-plated brass, NBR

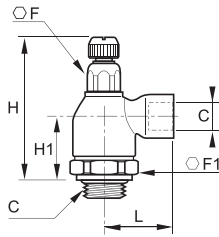

C		F	F1	H min	H max	H1	L	kg
G1/8	7111 10 10	10	19	47	52.5	23	22.5	0.079
G1/4	7111 13 13	14	19	50.5	55.5	25	32	0.107

7190 Miniature Flow Regulator Exhaust, Male/Female BSPP and Metric Thread



Nickel-plated brass, NBR

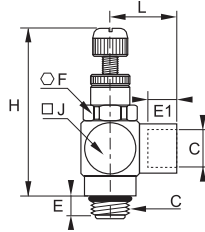

C		E	E1	F	H min	H max	J	L	kg
M5x0.8	7190 19 19	4	4	8	24	29	10	11	0.012
G1/8	7190 10 10	5	8	13	39	44	15	17	0.044

7762 Flow Regulator Exhaust, with Brass Compression Fitting, Male BSPP Thread



Brass, NBR

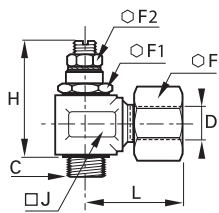

ØD	C		F	F1	F2	H min	H max	J	L	kg
8	G1/8	7762 08 10*	14	14	7	35.5	38.5	17	28.5	0.056
10	G1/4	7762 10 13	19	17	10	44	49	22	36.5	0.129
14	G3/8	7762 14 17	24	22	13	58	65	27	37.5	0.219
18	G1/2	7762 18 21	30	27	19	62.5	68.5	34	44	0.403

*with adjustment knurl

7170 Panel-Mountable In-Line Flow Regulator, Female BSPP and Metric Thread



Treated aluminium, NBR

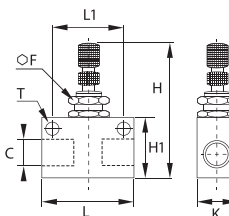

C		F	H min	H max	H1	K	L	L1	ØT	kg
M5x0.8	7170 19 19	12	38	42	15	12	25	18	4.5	0.022
G1/8	7170 10 10	15	49	56	22	18	35	24.7	4.5	0.056
G1/4	7170 13 13	15	57	64	30	20	46	35	6.5	0.086
G3/8	7170 17 17	22	62	73	30	25	50	35	6.5	0.155
G1/2	7170 21 21	22	72	83	40	25	60	44	6.5	0.196

Stainless Steel Flow Control Regulators

Stainless steel flow control regulators are used to **regulate the speed of a cylinder rod** as well as gas flow in environments with high mechanical or chemical constraints.

Product Advantages

Robust | Suitable for corrosive environments
Excellent mechanical and chemical resistance
100% leak-tested in production
No contamination of conveyed fluids

Optimised Design | Smooth external surfaces to facilitate cleaning
Fully compatible with food environments
Accurate and easy adjustment

Applications
Food Process
Robotics
Textile
Semi-Conductors
Packaging
Pneumatics
Automotive Process

Technical Characteristics

Compatible Fluids	Compressed air 7822: all compatible fluids depending on whether FKM or PTFE seals are used
Working Pressure	7810-7812: 1 to 10 bar 7820: 1 to 16 bar 7822: 1 to 40 bar
Working Temperature	7810 – 7812: 0°C to +70°C 7820 – 7822: -15° to +120°C

Component Materials



External Components

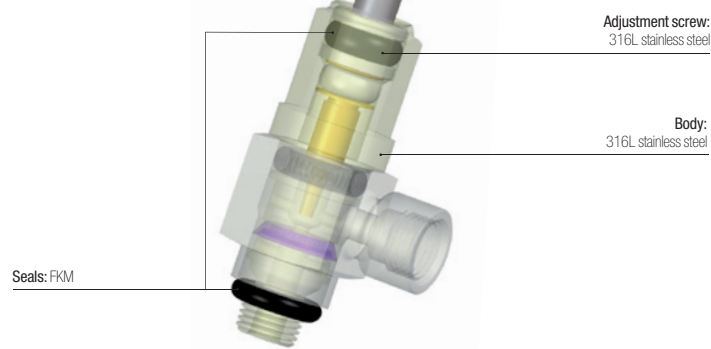

Regulations

DI: 2002/95/EC (RoHS)
RG: 1907/2006 (REACH)
DI: 97/23/EC (PED)
RG: External Components: 21CFR (FDA)
RG: External Components: 1935/2004/EC

Operation

Exhaust Model with External Adjustment

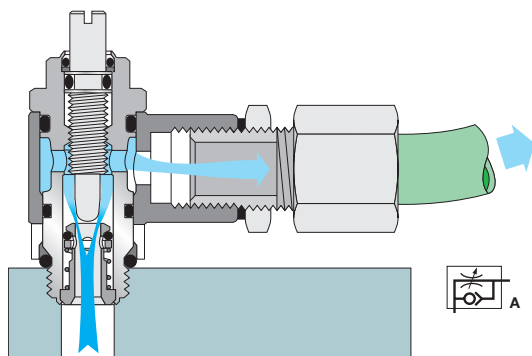

Bi-Directional Model with External Adjustment

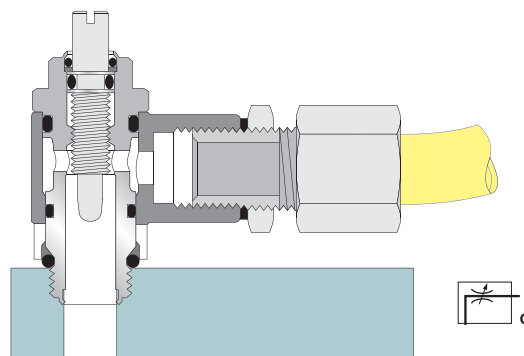

Stainless Steel Flow Control Regulators

7810 Flow Regulator Exhaust, Male/Female BSPP and Metric Thread



Stainless steel 316L, FKM

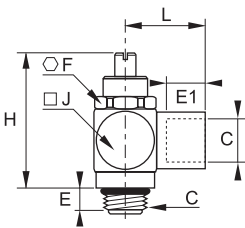

C		E	E1	F	H min	H max	J	L	kg
M5x0.8	7810 19 19	4	4	8	22	26	9	11	0.011
G1/8	7810 10 10	6	8	13	32	38	15	17	0.039
G1/4	7810 13 13	9	12	17	35	40	18	24	0.072
G3/8	7810 17 17	8	12	20	43	53	22	27	0.125
G1/2	7810 21 21	9	15	23	60	71	28	31	0.261

7812 Bi-Directional Flow Regulator, Male/Female BSPP and Metric Thread



Stainless steel 316L, FKM

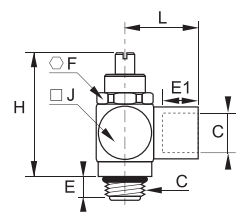

C		E	E1	F	H min	H max	J	L	kg
M5x0.8	7812 19 19	4	4	8	22	26	9	11	0.290
G1/8	7812 10 10	6	8	13	32	38	15	17	0.040
G1/4	7812 13 13	9	12	17	35	40	18	24	0.074
G3/8	7812 17 17	8	12	20	43	53	22	24	0.125
G1/2	7812 21 21	9	15	23	60	71	28	31	0.261

7820 In-Line One-Way Flow Regulator, Female BSPP Thread



Stainless steel 316L, FKM

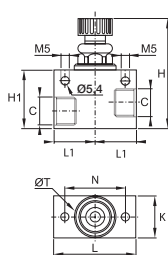

C	DN		H min	H max	H1	K	L	L1	N	ØT	kg
G1/8	7	7820 00 10	47	52.5	30	20	40	20	30	20	0.175
G1/4	7	7820 00 13	47	52.5	30	20	40	20	30	20	0.164
G3/8	9	7820 00 17	56	65	35	25	50	25	36	25	0.298
G1/2	12	7820 00 21	76	87	40	30	60	30	42	30	0.261

7822 Bi-Directional In-Line Flow Regulator, Female BSPP Thread



Stainless steel 316L, FKM

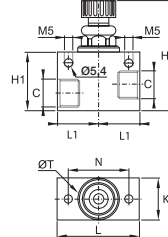

C	DN		H min	H max	H1	K	L	L1	N	ØT	kg
G1/8	7	7822 00 10	48	52.5	30	20	40	20	30	20	0.176
G1/4	7	7822 00 13	48	52.5	30	20	40	20	30	20	0.165
G3/8	9	7822 00 17	58	65	35	25	50	25	36	20	0.296
G1/2	12	7822 00 21	76	87	40	30	60	30	42	30	0.270

You will also find our range of stainless steel push-in fittings, compression fittings, valves and accessories in this catalogue.

Flow Characteristics (at 6 bar)

for Flow Control Regulators



7010
7011
7012

7010

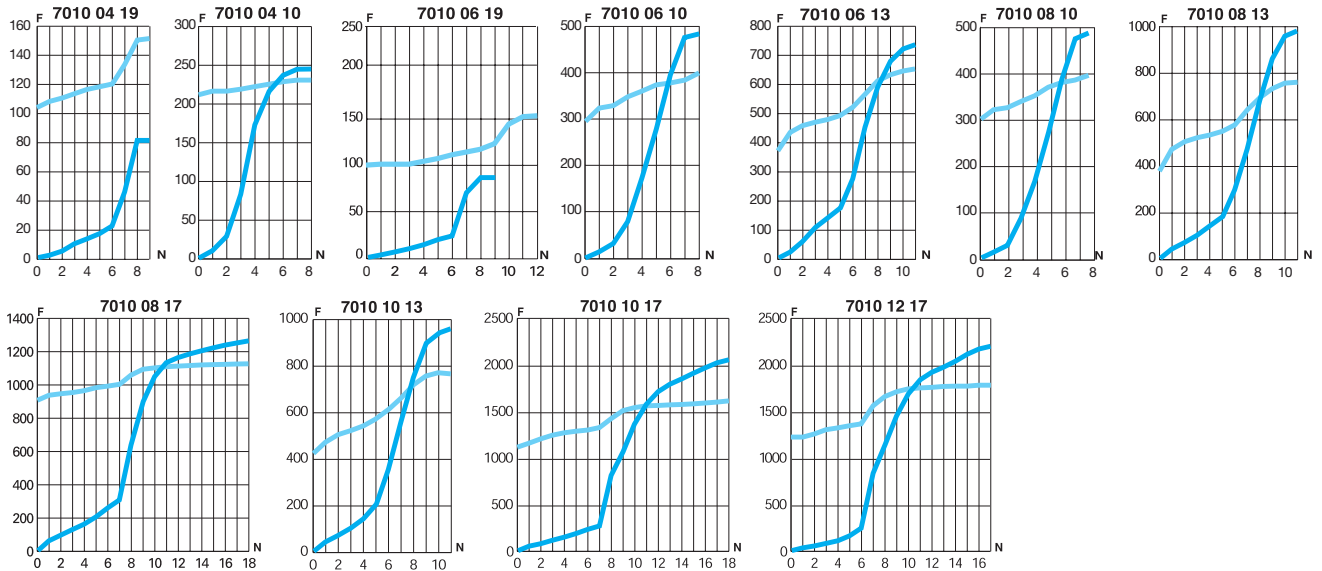

7011

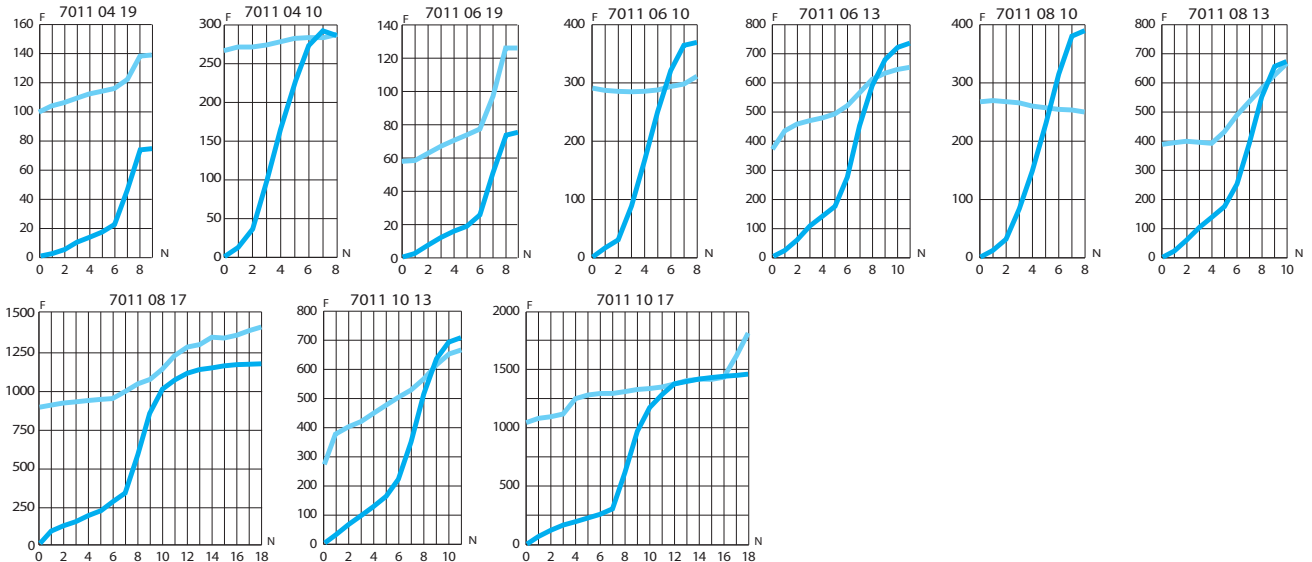

7012

Flow characteristics for model 7012:

- exhaust version (see model 7010, direction of adjustment)
- supply version (see model 7011, direction of adjustment)

6 bar

Direction of adjustment
 Return

F: Flow in NI/min

N: Number of turns

Flow Characteristics (at 6 bar)

for Flow Control Regulators



7060
7061
7062

7060

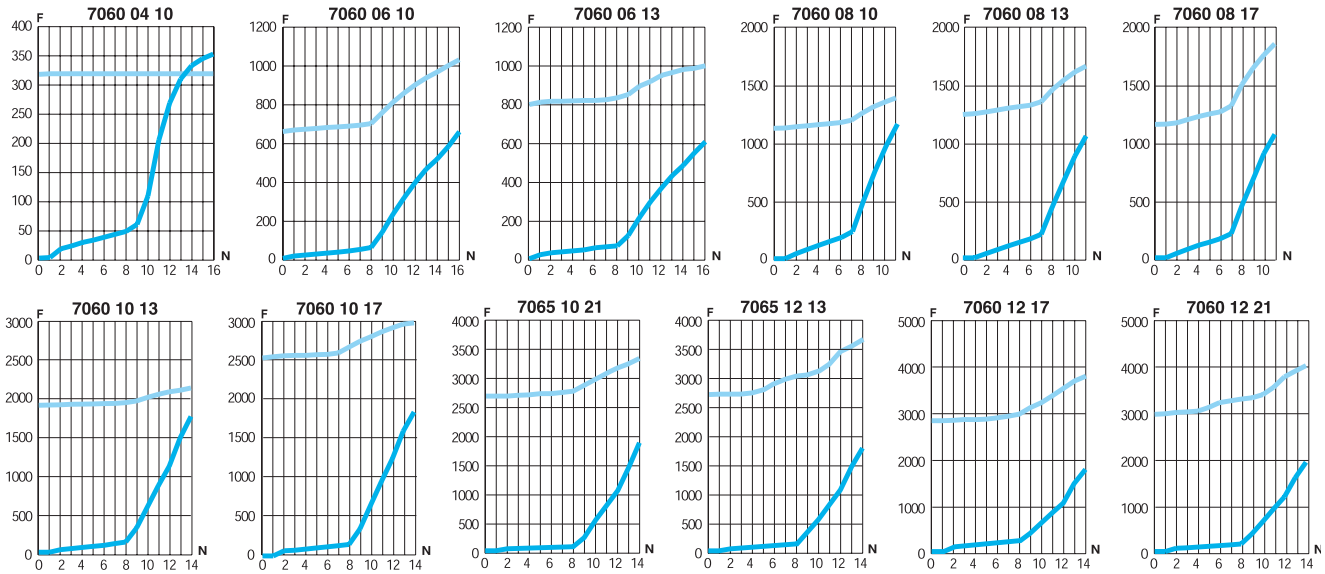

7061

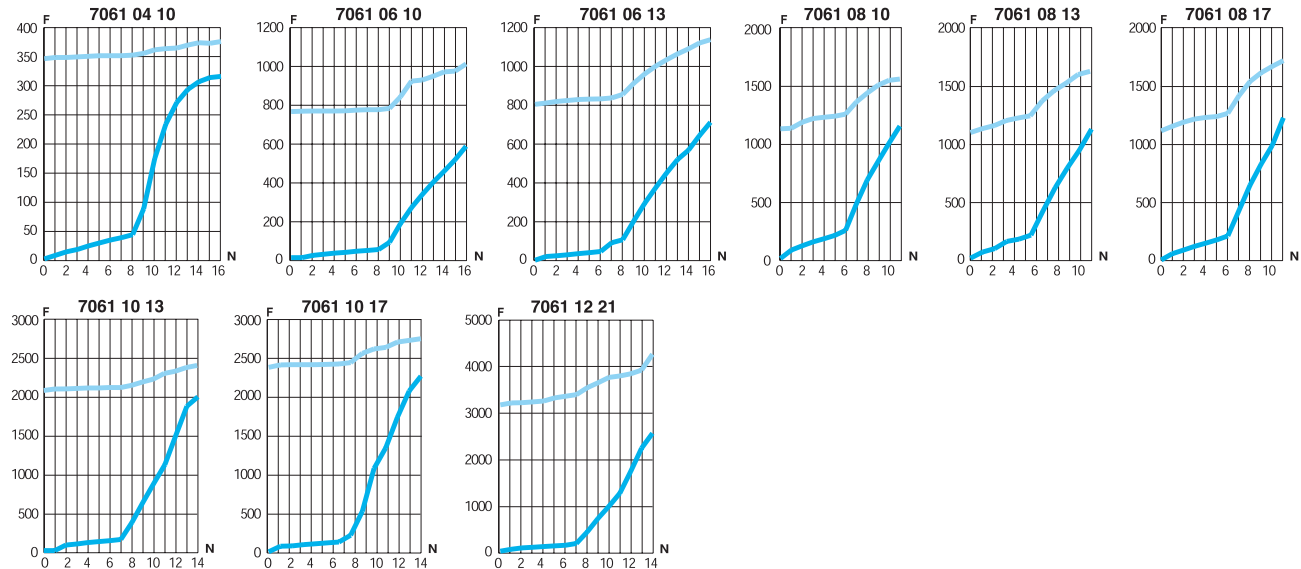

7062

Flow characteristics for model 7062:

- exhaust version (see model 7060, direction of adjustment)
- supply version (see model 7061, direction of adjustment)

Flow Characteristics (at 6 bar)

for Flow Control Regulators



7660
7669
7662

7660

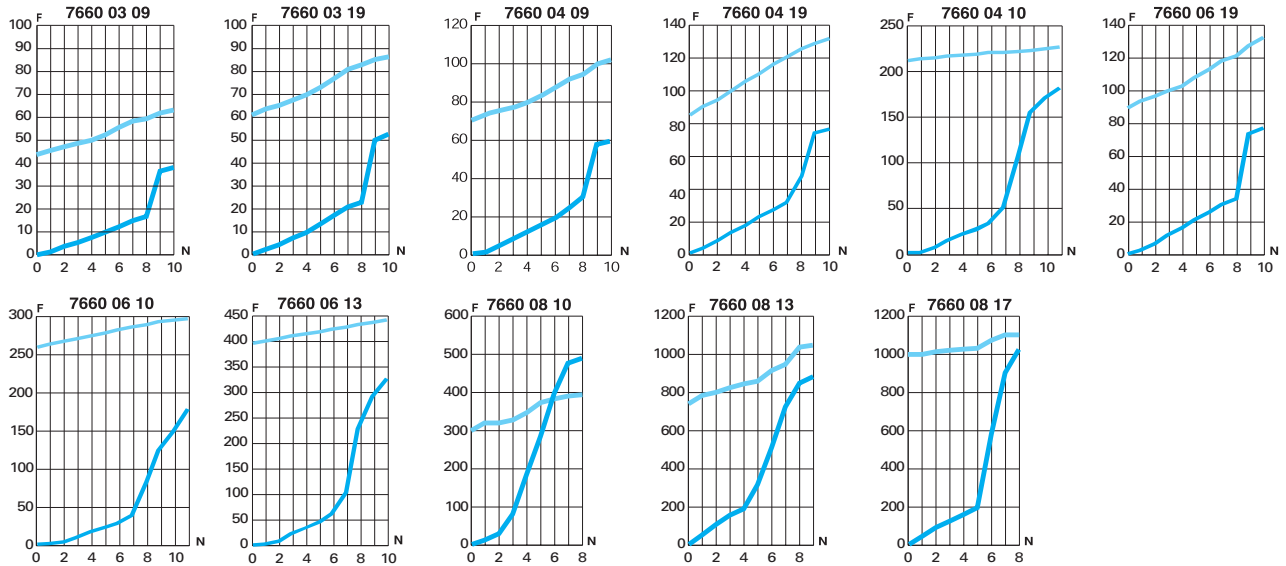

7669

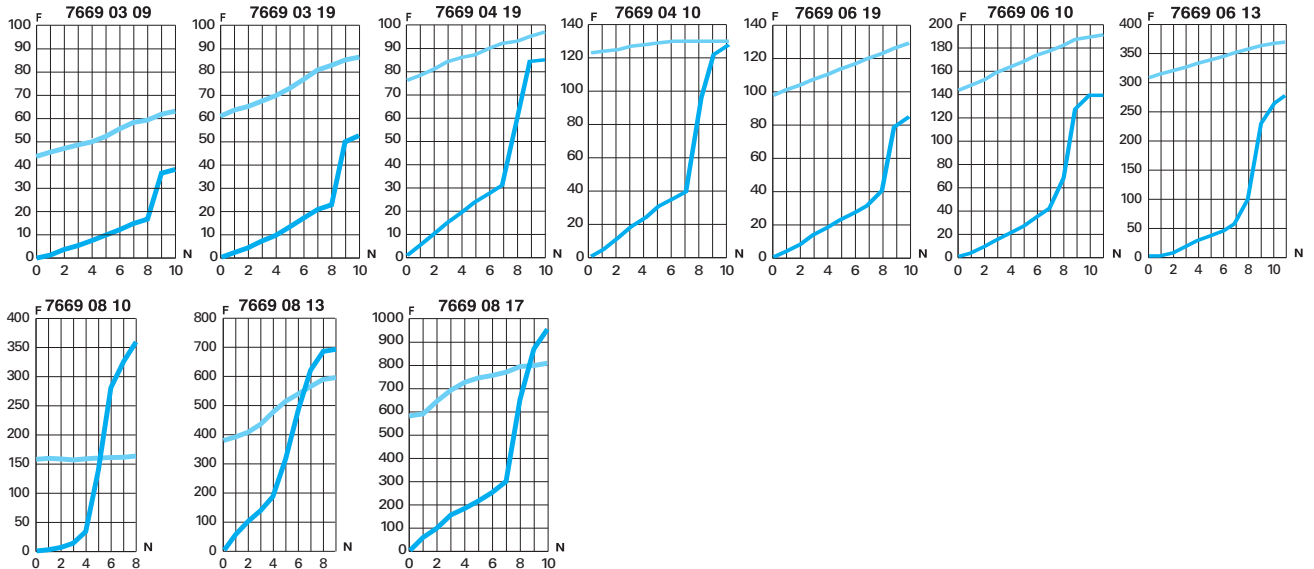

7662

Flow characteristics for model 7662:

- exhaust version: see model 7660, direction of adjustment
- supply version: see model 7669, direction of adjustment

6 bar

Direction of adjustment
 Return

F: Flow in Nl/min

N: Number of turns

Flow Characteristics (at 6 bar)

for Flow Control Regulators



7640
7649

7640

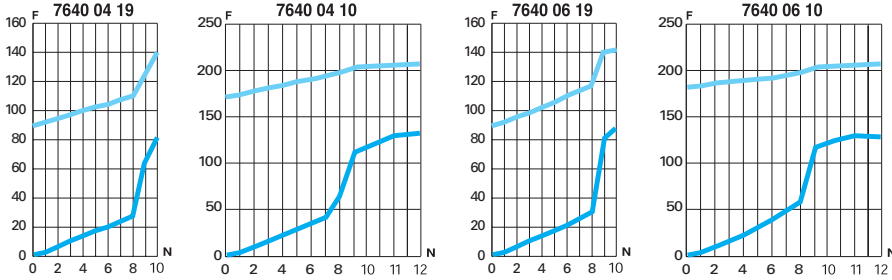

7649

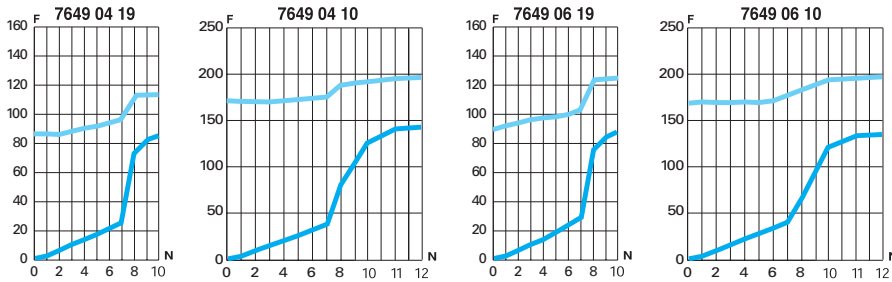

7771

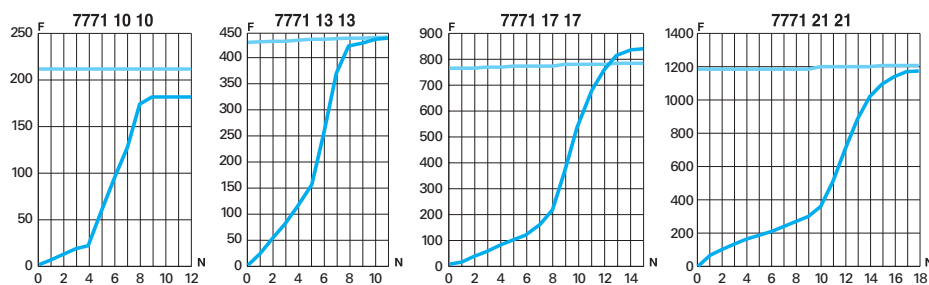

7020

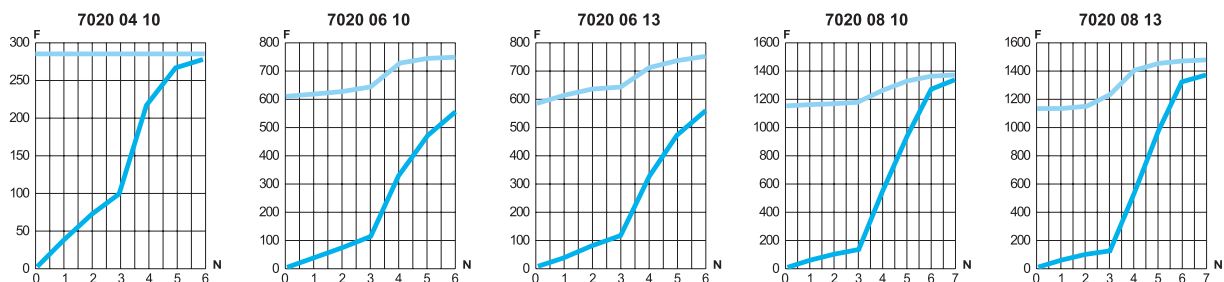

Flow Characteristics (at 6 bar)

for Flow Control Regulators



7770

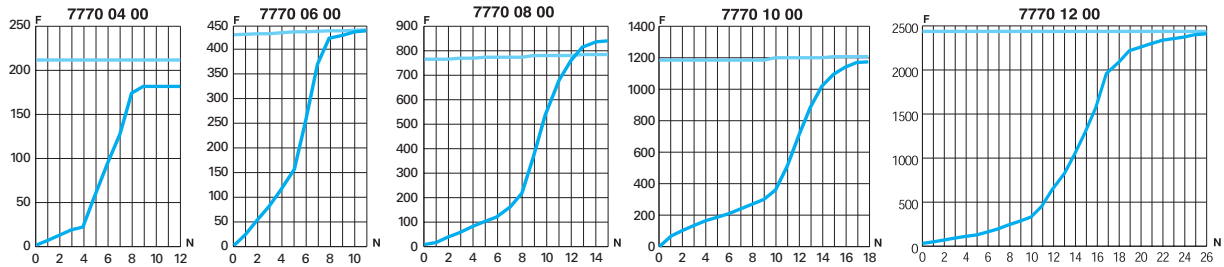

7776

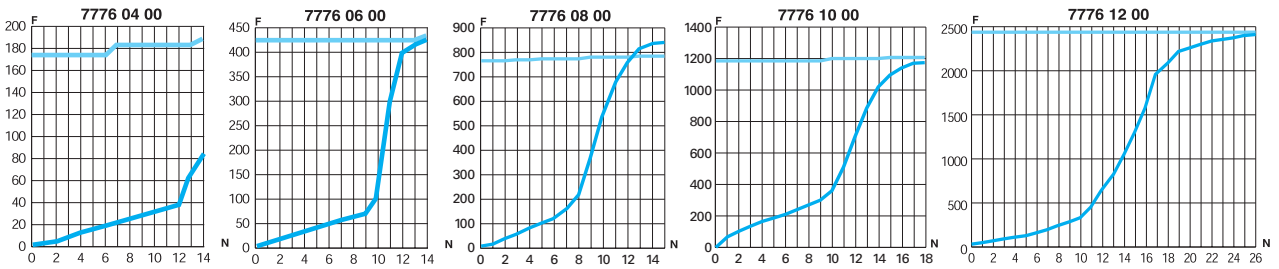

7030
7031

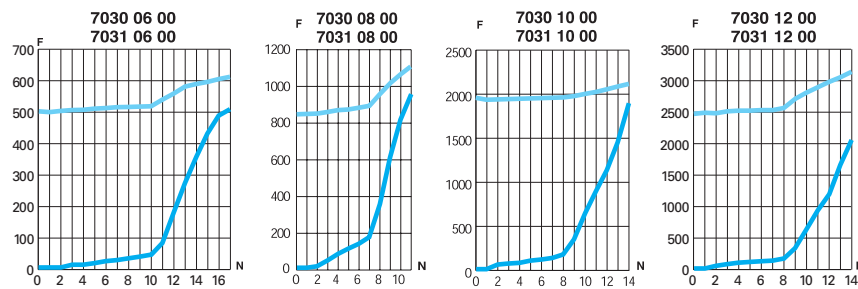

7630
7631

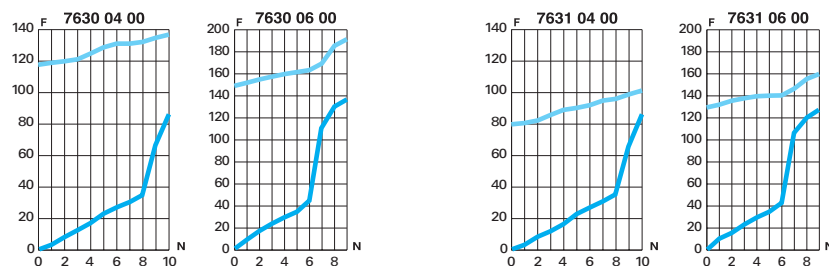

6 bar

Direction of adjustment

Return

F: Flow in NI/min

N: Number of turns

Flow Characteristics (at 6 bar)

for Flow Control Regulators



7065
7066
7067

7065

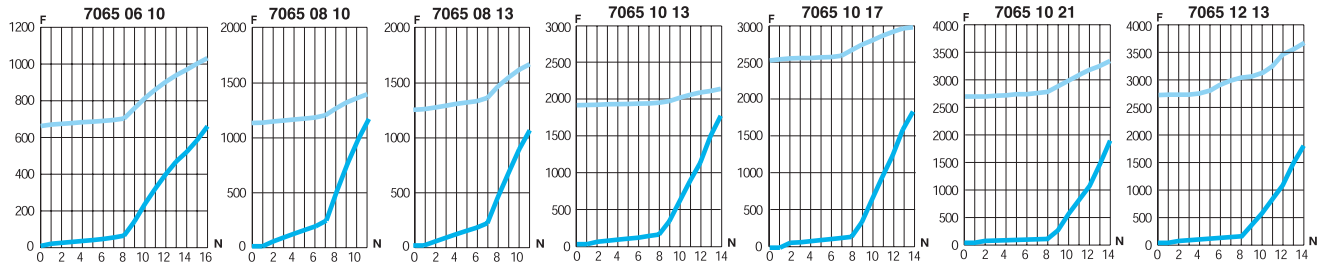

7066

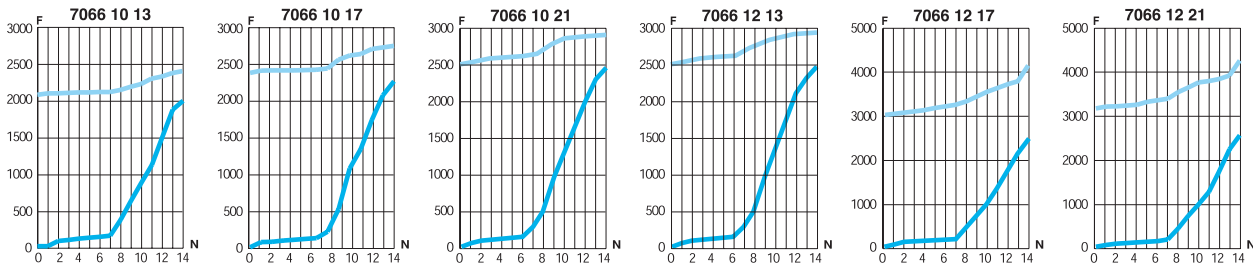

7067

Flow characteristics for model 7067:

- exhaust version: see model 7065, direction of adjustment
- supply version: see model 7066, direction of adjustment



7665
7668

7665

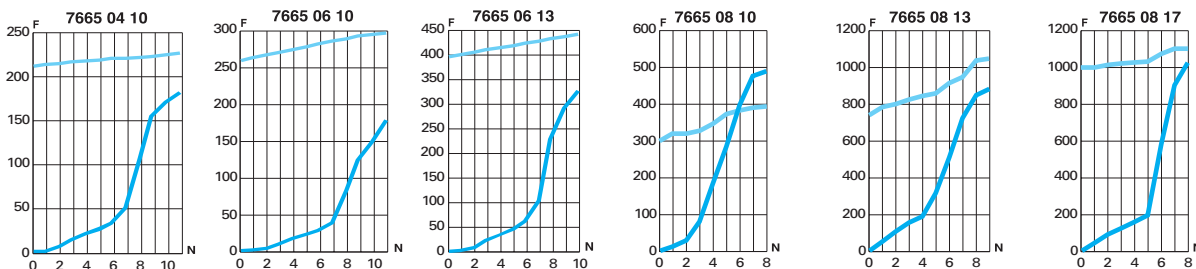

7668

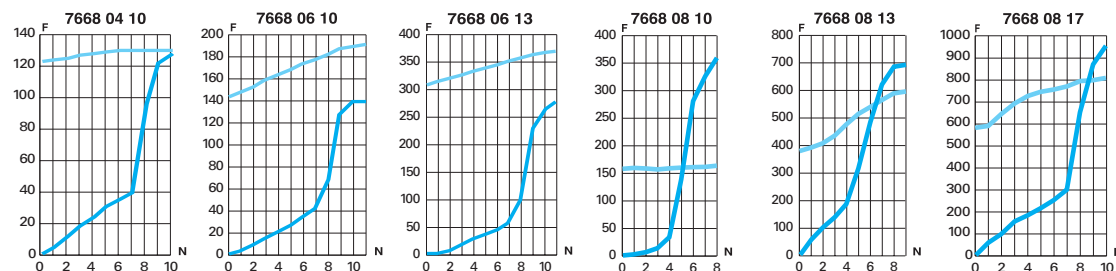

Flow Characteristics (at 6 bar)

for Flow Control Regulators



7045

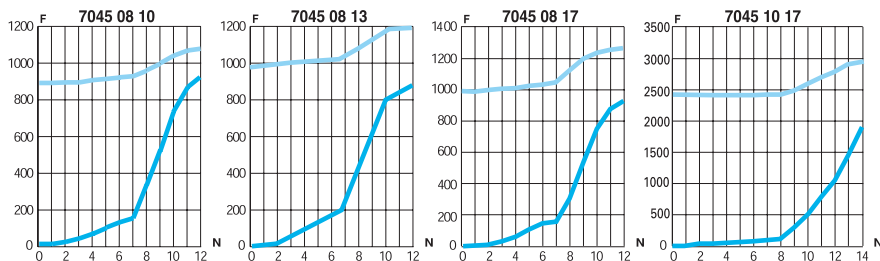

7130

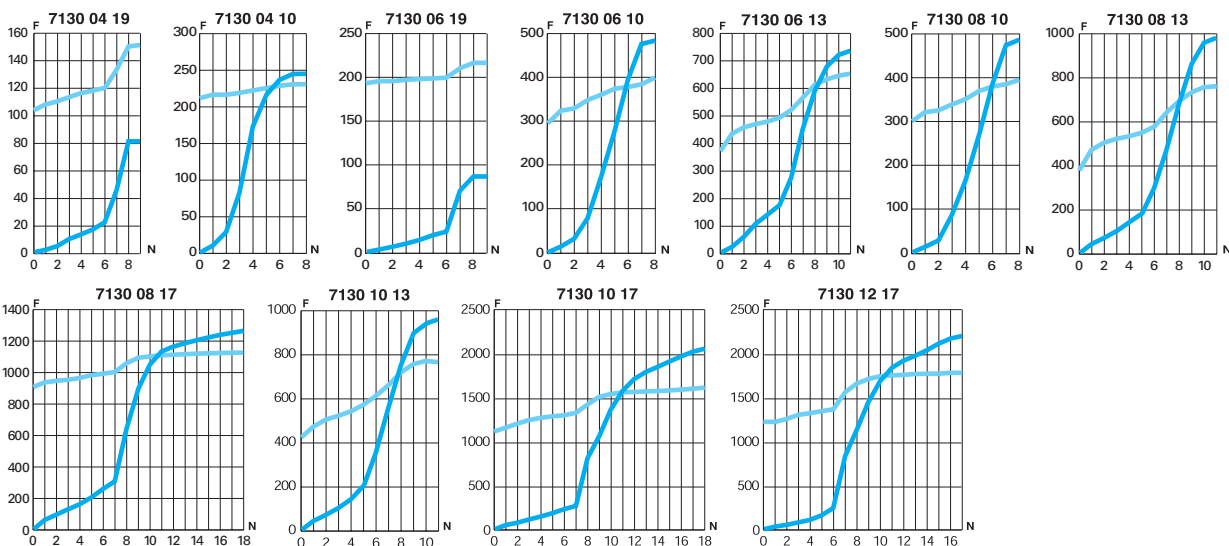

6 bar

Direction of adjustment
 Return

F: Flow in NI/min

N: Number of turns

Flow Characteristics (at 6 bar)

for Flow Control Regulators



7140

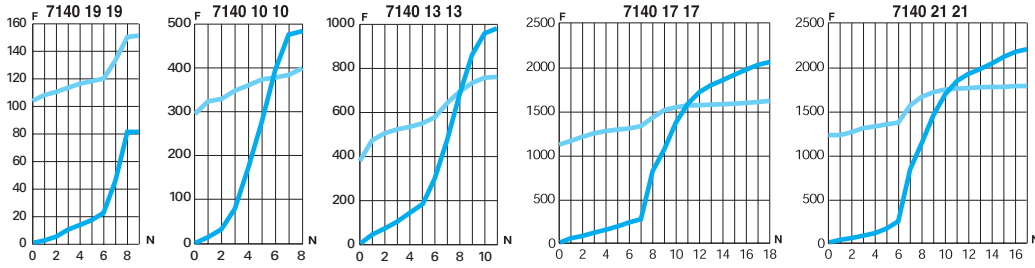

7160

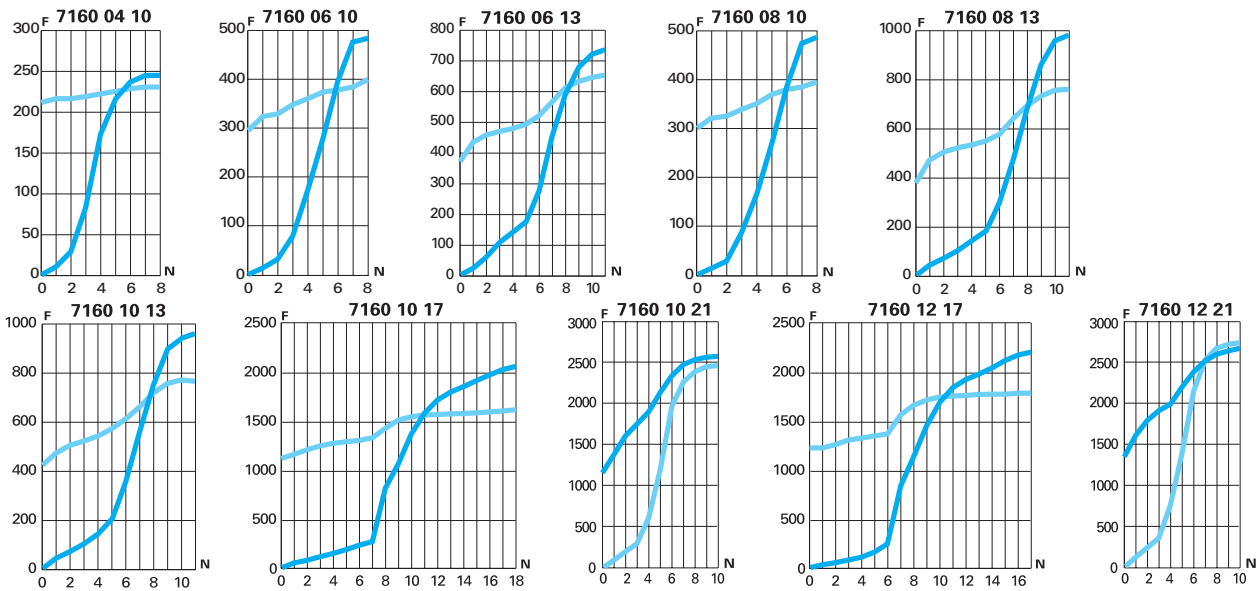

7762

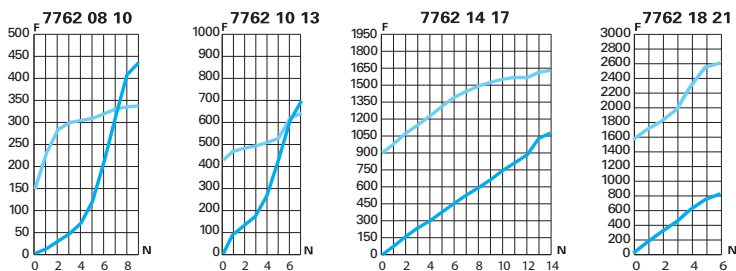

Flow Characteristics (at 6 bar)

for Flow Control Regulators



7100
7101

7100

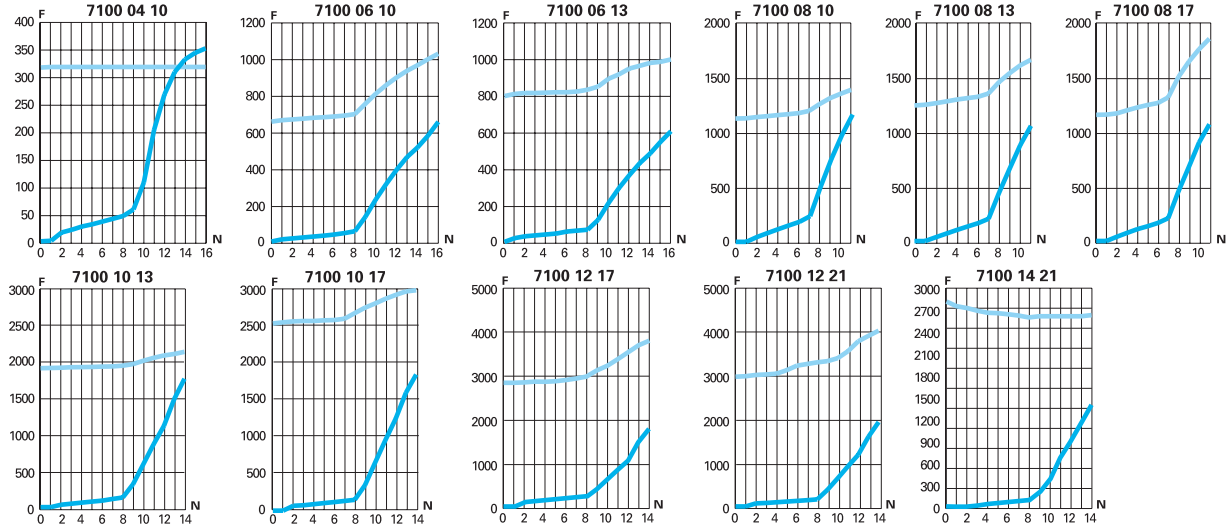

7101

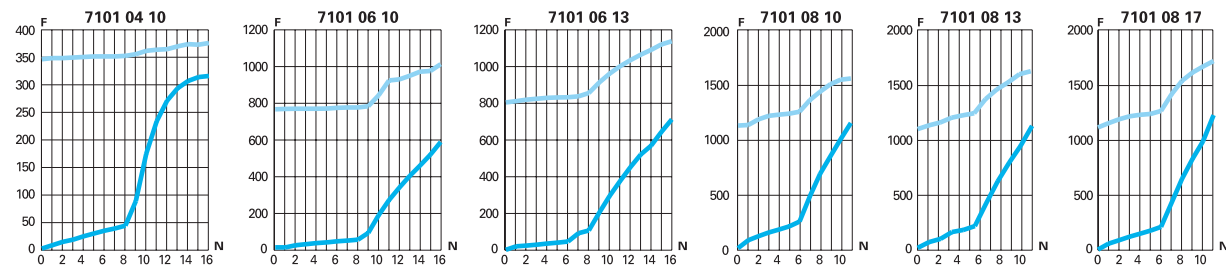

7680

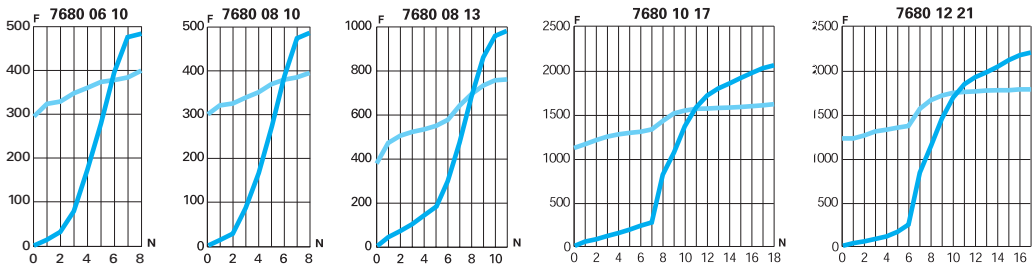

6 bar

Direction of adjustment
 Return

F: Flow in NI/min
N: Number of turns

Flow Characteristics (at 6 bar)

for Flow Control Regulators



7180

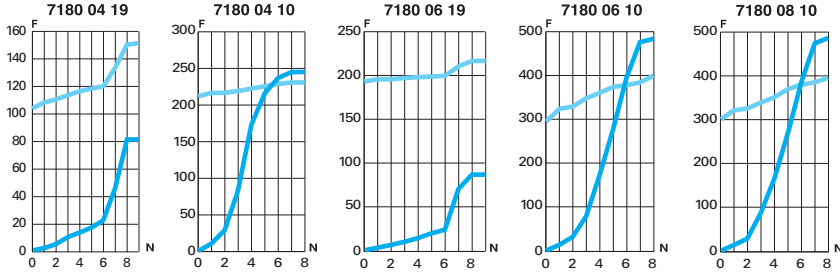

7110
7111

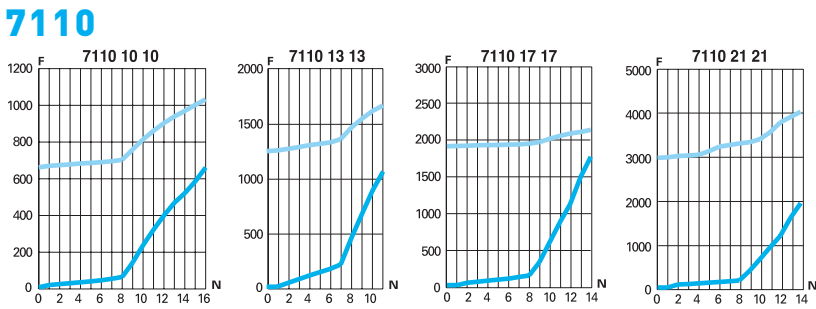

7111

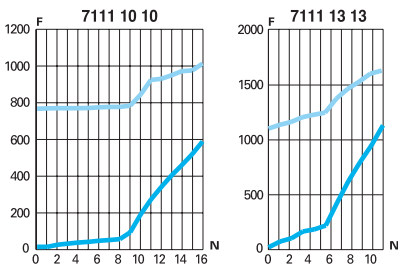

7170

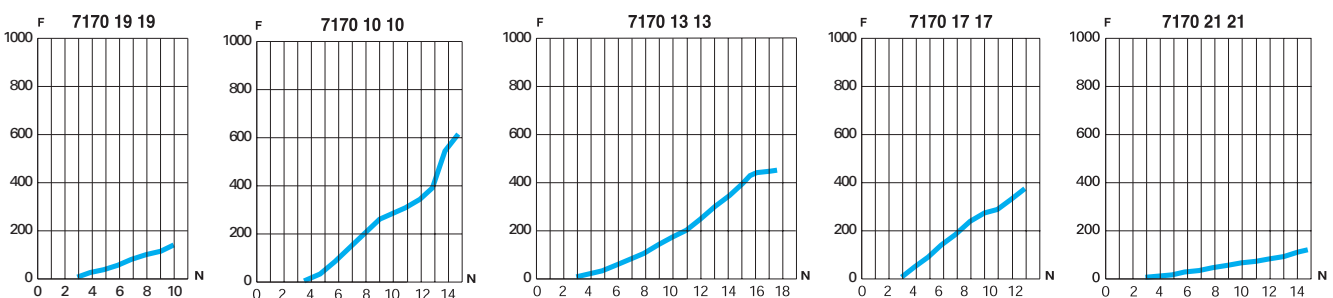

Function Fittings Range

Blocking Fittings

- 7880**
BSPP
Page 4-37
- 7881**
BSPP
Page 4-37
- 7885**
BSPT
Page 4-37
- 7886**
BSPT
Page 4-37
- 7883**
BSPP
Page 4-37



Piloted Non-Return Valves

- 7892**
BSPP
Page 4-39
- 7894**
BSPP
Page 4-39



Non-Return Valves

- 7996**
Page 4-41
- 7984**
7994
BSPP/Metric
Page 4-41
- 7985**
7995
BSPT
Page 4-41



Adjustable Non-Return Valves

- 7930**
BSPP/Metric
Page 4-43
- 7931**
BSPP
Page 4-43
- 7932**
BSPP
Page 4-43



LIQUIfit® Non-Return Valves

- 7992**
Page 4-45



Stainless Steel Non-Return Valves

- 4890**
BSPP
Page 4-47
- 4891**
BSPP
Page 4-47
- 4892**
BSPP
Page 4-47
- 4895**
NPT
Page 4-47



Soft Start Fittings

- 7860**
BSPP
Page 4-49
- 7870**
BSPP
Page 4-49
- 7861**
BSPP
Page 4-49
- 7871**
BSPP
Page 4-49



Pneumatic Sensor Fittings

- 7818**
BSPP/Metric
Page 4-51
- 7828**
BSPP/Metric
Page 4-51



Pressure Regulator Fittings

- 7300**
BSPP
Page 4-53



Pressure Reducer Fittings

- 7318**
BSPP
Page 4-55
- 7471**
BSPP
Page 4-55
- 7316**
Page 4-55
- 7416**
BSPP
Page 4-55
- 7000**
Page 4-55
- 7000**
Page 4-55



Snap Fittings

- 7926**
Page 4-57
- 7921**
BSPP
Page 4-57
- 7960**
Page 4-57
- 7961**
BSPP
Page 4-57



Manually-Operated Valves

- 7800**
7801
BSPP/Metric
Page 4-59
- 7802**
BSPP
Page 4-59
- 0669**
BSPP/Metric
Page 4-59



Function Fittings Range

Metal Quick Exhaust Valves

7970
BSPP/Metric
Page 4-61

7971
BSPP/BSPT
Page 4-61

7899
BSPP
Page 4-61



Silencers

0674
BSPP/Metric
Page 4-63

0676
BSPP/Metric
Page 4-63

0670
BSPP
Page 4-63

0673
BSPP/Metric
Page 4-63

0675
BSPP/Metric
Page 4-63

0671
Page 4-64

0677
BSPP
Page 4-64

0672
BSPP
Page 4-64

0682
BSPP
Page 4-64

0683
NPT
Page 4-64



Blocking Fittings

Blocking fittings, mounted in pairs on a cylinder, lock the piston by simultaneously **cutting off the supply and exhaust** when the pilot signal is removed.

Product Advantages

Optimum Performance

- Optimum flow: no effect on the performance of the cylinder
- Compact size
- Fully orientable for excellent flexibility in circuit installation
- 100% leak-tested in production
- Date coding to guarantee quality and traceability

Robust

- Suitable for the most demanding environments
- Excellent corrosion and spark resistance to salt spray and sparks (threaded models)
- Proven push-in technology



Applications

- Robotics
- Machine Tools
- Textile
- Packaging
- Pneumatics
- Automotive Process

Technical Characteristics

Compatible Fluids	Compressed air
Working Pressure	1 to 10 bar
Working Temperature	-20°C to +70°C

Connection	Supply Flow 6 bar	Pilot and depilot threshold depending on supply pressure				
		2 bar	4 bar	6 bar	8 bar	10 bar
ØD 6 and 8 mm, threads G1/8, G1/4, R1/8, R1/4	Pilot Pressure	2.40	2.90	3.30	3.60	4.00
	Depilot Pressure	1.50	1.80	2.15	2.40	2.80
ØD 10 and 12 mm, threads G3/8, G1/2, R3/8, R1/2	Pilot Pressure	2.70	3.20	3.50	3.80	4.10
	Depilot Pressure	1.40	1.80	2.10	2.40	2.70

Component Materials

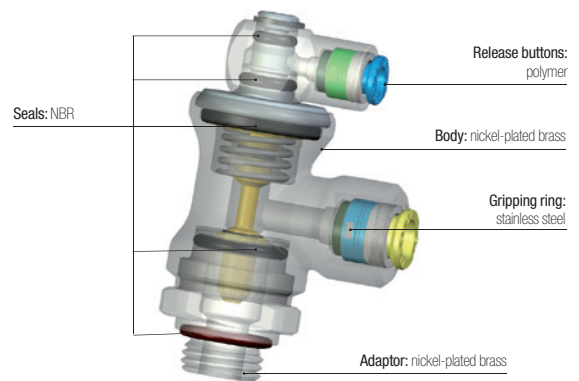

Silicone-free

Regulations

- DI: 2002/95/EC (RoHS)
- DI: 97/23/EC (PED)
- RG: 1907/2006 (REACH)

Operation

Cylinder in Operation (pilot signal active)

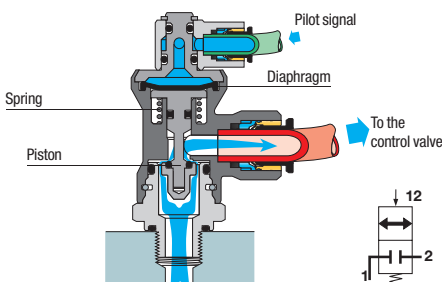

Pilot signal authorises movement

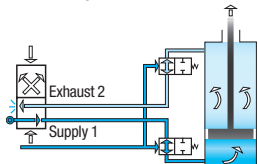

Cylinder Blocked (pilot signal removed)

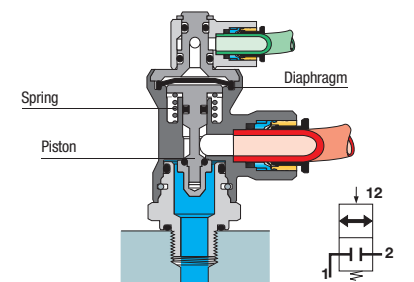

No signal blocks movement

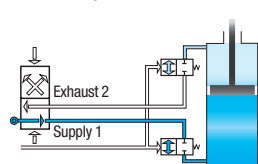

Installation

Mounted in pairs, blocking fittings are installed directly on the cylinder. Being fully orientable, they offer excellent flexibility in the design and installation of pneumatic circuits.

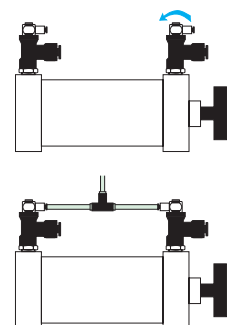

Blocking Fittings

7880 Blocking Fitting, Male BSPP Thread



Nickel-plated brass, NBR

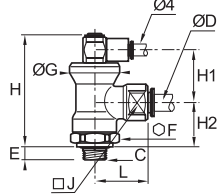

ØD	C		E	F	G	H	H1	H2	J	L	kg
6	G1/8	7880 06 10	5.5	21	24	53	24.5	21	17	28	0.126
	G1/4	7880 06 13	6.5	21	24	53	24.5	21	17	28	0.128
8	G1/4	7880 08 13	6.5	21	24	53	24.5	21	17	28	0.122
	G3/8	7880 08 17	7.5	21	24	53	24.5	21	17	28	0.127
10	G3/8	7880 10 17	7.5	24	28	58	25	25	27	35	0.209
12	G1/2	7880 12 21	9	24	28	58	25	25	27	37.5	0.222

7885 Blocking Fitting, Male BSPT Thread



Nickel-plated brass, NBR

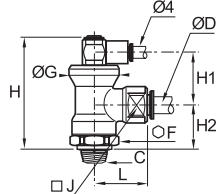

ØD	C		F	G	H	H1	H2	J	L	kg
6	R1/8	7885 06 10	21	24	51.5	25	20	17	28	0.127
	R1/4	7885 06 13	21	24	51.5	25	20	17	28	0.131
8	R1/4	7885 08 13	21	24	51.5	25	20	17	28	0.126
	R3/8	7885 08 17	21	24	51.5	25	20	17	28	0.130
10	R3/8	7885 10 17	24	28	57	25	24	27	35	0.222
	R1/2	7885 12 21	24	28	57	25	24	27	37.5	0.229

7881 Blocking Fitting, Male/Female BSPP Thread



Nickel-plated brass, NBR

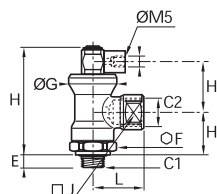

C1	C2		E	F	G	H	H1	H2	J	L	kg
G1/8	G1/4	7881 13 10	5.5	21	24	53	24.5	21	17	25.5	0.118
G1/4	G1/4	7881 13 13	6.5	21	24	53	24.5	21	17	25.5	0.119
G3/8	G3/8	7881 17 17	7.5	24	28	58	25	25	27	34	0.211
G1/2	G1/2	7881 21 21	9	24	28	58	25	25	27	40	0.226

7886 Blocking Fitting, Male/Female BSPT Thread



Nickel-plated brass, NBR

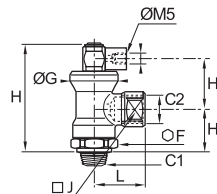

C1	C2		F	G	H	H1	H2	J	L	kg
R1/8	R1/4	7886 13 10	21	24	51.5	25	20	17	26.5	0.121
R1/4	R1/4	7886 13 13	21	24	51.5	25	20	17	26.5	0.126
R3/8	R3/8	7886 17 17	24	28	57	25	24	27	34	0.225
R1/2	R1/2	7886 21 21	24	28	57	25	24	27	40	0.240

7883 Blocker/Flow Regulator, Male BSPP Thread

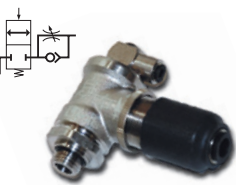

Nickel-plated brass, technical polymer, NBR

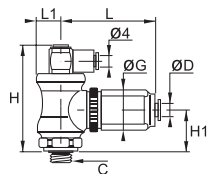

ØD	C		G	H	H1	L	L _{max}	L1	kg
4	G1/8	7883 04 10	21.5	53	21	46.5	52	12	0.166
	G1/4	7883 06 10	21.5	53	21	46.5	52	12	0.163
6	G1/4	7883 06 13	21.5	53	21	46.5	52	12	0.166
	G1/4	7883 08 13	27	57.5	24.5	54	60	14	0.251
8	G3/8	7883 08 17	27	57.5	24.5	54	60	14	0.254

Combination of blocking and flow regulation functions
Working temperature: 0 to +70°C

Piloted Non-Return Valves

Piloted non-return valves are designed to **protect installations**: if the compressed air supply is removed, they lock the air supply to the cylinder, thus maintaining it in position.

Product Advantages

- System Protection** | Protection of your system
 Control of inlet and outlet flow: cylinder operation optimised
 Vent saves time on restart after maintenance operations (model 7894)
- 3 Functions in 1 Product** | A multi-purpose fitting:
 - piloted non-return valve
 - flow control regulator
 - manual exhaust
 All-in-one product: integrated fittings for the control and supply
- Flexible Operation** | Orientable and adjustable through 3 axes
 Can be integrated into any installation configuration
 Push-in connection for quicker and more reliable installation
 Mounted in pairs directly on the cylinder



Applications

- Pneumatics
- Assembly
- Robotics
- Machine Tools
- Packaging
- Handling
- Automotive Process

Technical Characteristics

Compatible Fluids	Compressed air
Working Pressure	1 to 10 bar
Working Temperature	-5°C to +60°C
Cracking Pressure	0.3 bar

Component Materials

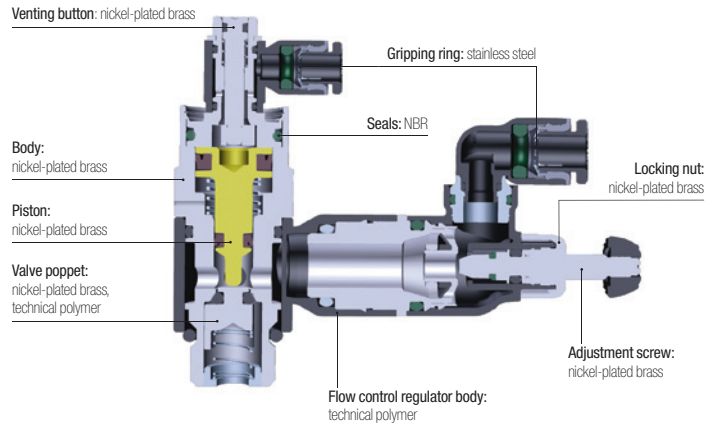

Silicone-free

Regulations

DI: 2002/95/EC (RoHS)
 RG: 1907/2006 (REACH)
 DI: 97/23/EC (PED)

Operation

Normal Operation

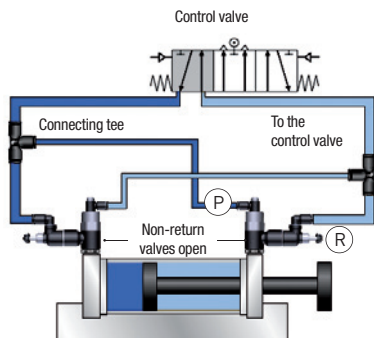

Pilot signal (P)
 Regulation of cylinder rod speed (R)

Emergency Stop or Pressure Drop

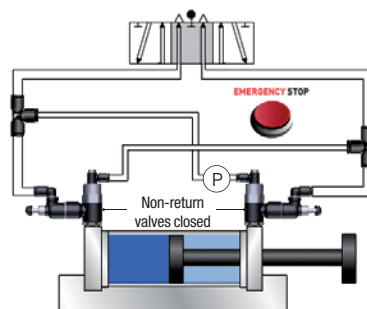

Drop/removal of pilot pressure (P) = cylinder rod locked

Venting Operation

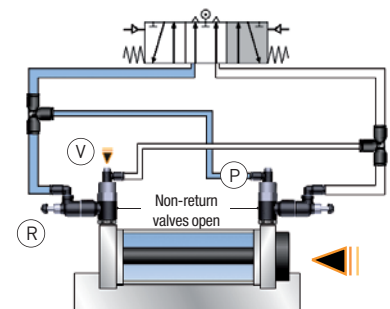

Venting (V) returns the cylinder rod to the start position, employing the pressure chamber through the flow regulator (R) and pilot line (P)

Piloted Non-Return Valves

7892

Piloted Non-Return Valve, Male BSPP Thread



Technical polymer, nickel-plated brass, NBR

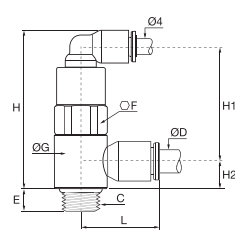

ØD	C		E	F	G	H	H1	H2	L	kg
6	G1/8	7892 06 10	6	13	14	42	30	7	21	0.020
	G1/4	7892 06 13	9	17	18.5	45	32	9	23	0.042
8	G1/8	7892 08 10	6	13	14	42	29	9	25	0.020
	G1/4	7892 08 13	9	17	18.5	45	32	9	27	0.042
10	G3/8	7892 08 17	6	20	22.5	57	41	11	28	0.093
	G3/8	7892 10 17	6	20	22.5	57	41	11	31	0.144
12	G1/2	7892 10 21	10	24	28	63	47	16	36	0.109
12	G1/2	7892 12 21	10	24	28	63	47	16	36	0.150

7894

Piloted Non-Return Valve with Flow Regulator and Exhaust, Male BSPP Thread



Technical polymer, nickel-plated brass, NBR

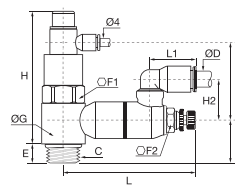

ØD	C		E	F1	F2	G	H	H1	H2	H3	L	L _{max}	L1	kg
6	G1/8	7894 06 10	6	13	8	14	46	7	24	31	48.5	51	16	0.041
	G1/4	7894 06 13	9	17	10	18.5	49	11	18	31	59.5	65	17	0.067
8	G1/8	7894 08 10	6	13	8	14	46	7	27	31	48.5	51	22	0.051
	G1/4	7894 08 13	9	17	10	18.5	49	11	23	31	59.5	65	23	0.068
10	G3/8	7894 08 17	7	20	14	22.5	69	13	21	40	67.5	73	23	0.060
	G3/8	7894 10 17	7	20	14	22.5	69	13	29	40	67.5	73	26	0.061
12	G1/2	7894 10 21	9	24	17	28	76	12.5	26	47	74	81	26	0.234
	G1/2	7894 12 21	9	24	17	28	76	12.5	27	47	74	81	30	0.237

3104

Unequal Tee



Technical polymer, NBR

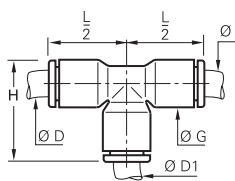

ØD	ØD1		G	H	L/2	kg
6	4	3104 06 04	10.5	22.5	17.5	0.005
8	4	3104 08 04	13.5	29	22.5	0.014
10	4	3104 10 04	16	33	26	0.027
12	4	3104 12 04	19	39	31	0.034

Model	Pilot and depilot threshold					
		2 bar	4 bar	6 bar	8 bar	10 bar
G1/8	Pilot Pressure	1.2	1.72	2.44	2.96	3.56
	Depilot Pressure	0.56	0.96	1.12	1.76	2.12
G1/4	Pilot Pressure	0.92	1.52	2.12	2.68	3.28
	Depilot Pressure	0.64	1.16	1.68	2.16	2.64
G3/8	Pilot Pressure	1.12	1.84	2.56	3.32	4.08
	Depilot Pressure	0.64	1.04	1.44	1.84	2.36
G1/2	Pilot Pressure	1.04	1.60	2.12	2.76	3.88
	Depilot Pressure	0.76	1.28	1.76	2.20	2.72

Maximum Flow at 6 bar (NI/min)	7894 06 10	7894 06 13	7894 08 10	7894 08 13	7894 08 17	7894 10 17	7894 10 21	7894 12 21
Direction of Adjustment	250	475	240	585	875	940	1535	1560
Return	365	620	355	815	1085	1205	1860	1940

Non-Return Valves

Non-return valves allow compressed air to flow in one direction and prevent it from flowing in the other. Fitted upstream of the circuit to be protected, they provide **total protection**.

Product Advantages

Variety of Applications | Wide range
 Push-in connection: ease of use
 Available in threaded or push-in version

Powerful Design | Lip seals for improved sealing performance
 Excellent vibration resistance
 Compact
 Lightweight
 Symbol showing the operating direction of flow
 Safe installation with colour codes:
 • green push-button: supply version
 • red push-button: exhaust version



Applications
 Automotive Process
 Robotics
 Vacuum
 Textile
 Semi-Conductors
 Packaging
 Pneumatics

Technical Characteristics

Compatible Fluids	Compressed air	
Working Pressure	1 to 10 bar	
Working Temperature	0°C to +70°C	
Cracking Pressure	0.3 bar	
Flow Characteristics (NI/min)	Model	Flow at 6 bar
	4 mm	350
	6 mm	670
	8 mm	1080
	10 mm	2230
	12 mm	2300

Component Materials

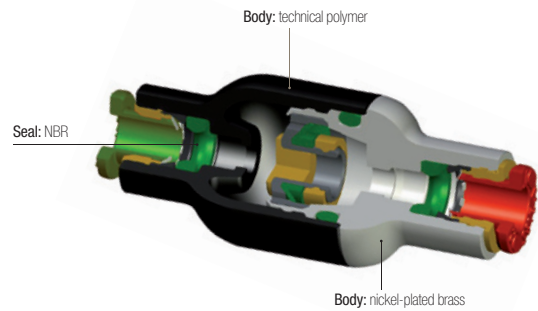

Silicone-free

Regulations

DI: 2002/95/EC (RoHS)
 RG: 1907/2006 (REACH)
 DI: 97/23/EC (PED)

Operation

In-Line Version	Supply Version	Exhaust Version	Installation Diagram
<p>Non-return valve</p>	<p>Non-return valve</p> <p>Models 7984-7985</p>	<p>Non-return valve</p> <p>Models 7994-7995</p>	

Non-Return Valves

7996 In-Line Equal Non-Return Valve



Technical polymer, nickel-plated brass, NBR

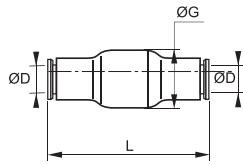

ØD		G	L	kg
4	7996 04 00	16	38.5	0.008
6	7996 06 00	16	41	0.013
8	7996 08 00	19	51.5	0.017
10	7996 10 00	23	63.5	0.070
12	7996 12 00	23	66.5	0.050

7984 In-Line Non-Return Valve, Supply, Male BSPP and Metric Thread



Technical polymer, nickel-plated brass, NBR

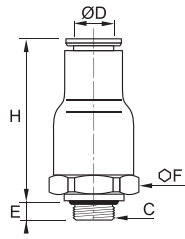

ØD	C		E	F	H	kg
4	M5x0.8	7984 04 19	3	9	32	0.008
	G1/8	7984 04 10	5	16	28.5	0.015
6	G1/8	7984 06 10	5	16	30.5	0.015
	G1/4	7984 06 13	5.5	16	30.5	0.015
8	G1/8	7984 08 10	5	19	36	0.021
	G1/4	7984 08 13	5.5	19	36	0.023
10	G3/8	7984 10 17	5.5	23	42	0.047
	G3/8	7984 12 17	5.5	23	42	0.010
12	G1/2	7984 12 21	7.5	23	44	0.041

7994 In-Line Non-Return Valve, Exhaust, Male BSPP and Metric Thread



Technical polymer, nickel-plated brass, NBR

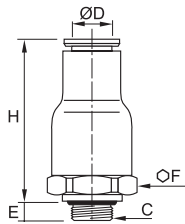

ØD	C		E	F	H	kg
4	M5x0.8	7994 04 19	3	9	32	0.790
	G1/8	7994 04 10	5	16	28.5	0.018
6	G1/8	7994 06 10	5	16	30.5	0.015
	G1/4	7994 06 13	5.5	16	30.5	0.015
8	G1/8	7994 08 10	5	19	36	0.023
	G1/4	7994 08 13	5.5	19	36	0.023
10	G3/8	7994 10 17	5.5	23	42	0.050
	G3/8	7994 12 17	5.5	23	42	0.043
12	G1/2	7994 12 21	7.5	23	44	0.045

7985 In-Line Non-Return Valve, Supply, Male BSPT Thread



Technical polymer, nickel-plated brass, NBR

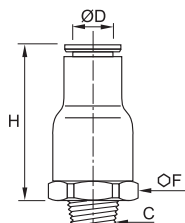

ØD	C		F	H	kg
4	R1/8	7985 04 10	16	28.5	0.016
	R1/8	7985 06 10	16	30.5	0.016
6	R1/4	7985 06 13	16	30.5	0.021
	R1/8	7985 08 10	19	36	0.022
8	R1/4	7985 08 13	19	36	0.020
	R3/8	7985 10 17	23	42	0.049
10	R3/8	7985 12 17	23	42	0.042
	R1/2	7985 12 21	23	44	0.048

Pre-coated thread

7995 In-Line Non-Return Valve, Exhaust, Male BSPT Thread



Technical polymer, nickel-plated brass, NBR

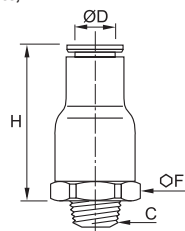

ØD	C		F	H	kg
4	R1/8	7995 04 10	16	28.5	0.015
	R1/8	7995 06 10	16	30.5	0.016
6	R1/4	7995 06 13	16	30.5	0.022
	R1/8	7995 08 10	19	36	0.022
8	R1/4	7995 08 13	19	36	0.026
	R3/8	7995 10 17	23	42	0.048
10	R3/8	7995 12 17	23	42	0.042
	R1/2	7995 12 21	23	44	0.048

Pre-coated thread

Nickel-Plated Brass Adjustable Non-Return Valves

These nickel-plated brass adjustable non-return valves, suitable for **harsh environments**, allow compressed air to flow in one direction and prevent flow in the other. This product incorporates **precise adjustment** of opening pressure for greater flexibility.

Product Advantages

- Robust** | Excellent resistance to abrasion and corrosion
Developed for the food process industry
- Optimised Inventory Management** | A single valve for multiple opening pressure settings
Limits the number of versions
Flexibility of use
- Protection & Safety** | Maintains downstream pressure if upstream pressure drops
Designed with locking nut to protect initial setting in the event of:
 - vibration
 - intensive use
 - accidental handling
 Adjustment and locking of the non-return valve cracking pressure with two different Allen keys prevents the settings from being accidentally changed
Smooth external profile to facilitate cleaning in situ
Maximum constant flow guaranteed whatever the setting of the cracking pressure



Applications

- Printing
- Machine Tools
- Food Process
- Petrochemical
- Textile
- Automotive Process
- Chemical

Technical Characteristics

Compatible Fluids	Compressed air					
Working Pressure	0 to 12 bar					
Working Temperature	-20°C to +80°C					
Cracking Pressure	Threads		0 to 4 turns (values given as an example only)			
	M5x0.8 - G1/8 - G1/4		1 to 0.10 bar			
	G3/8		1 to 0.15 bar			
	G1/2		1 to 0.20 bar			
Max. Tightening Torques	Threads	M5x0.8	G1/8	G1/4	G3/8	G1/2
	daN.m	0.16	0.8	1.2	3	3.5

Component Materials

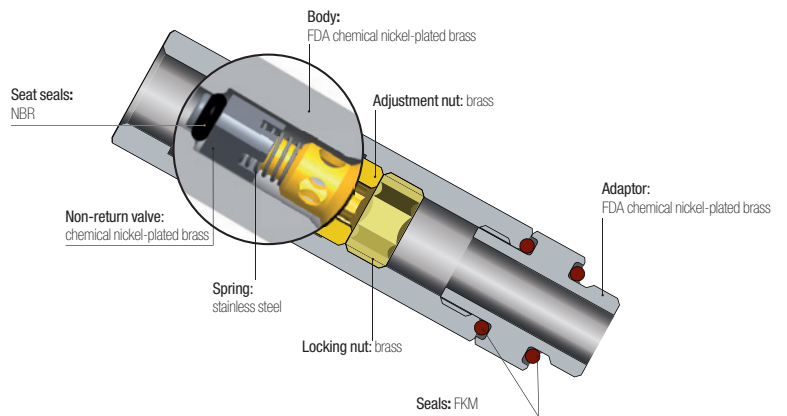

Silicone-free

Regulations

- DI: 2002/95/EC (RoHS)
- RG: External Components: 21CFR (FDA)
(seal: § 177.2600, nickel: §184.1537, grease: NSF H1)
- RG: 1935/2004 (external surface flow \geq 0.02 litre per hour)
- DI: 2006/42/EC (external surface Pa < 0.8 μ m)
- RG: 1907/2006 (REACH)

Operation

Step 1

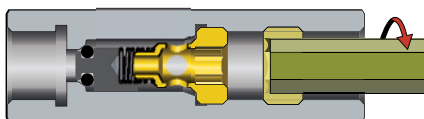

Unscrew the locking nut with an Allen key.

Step 2

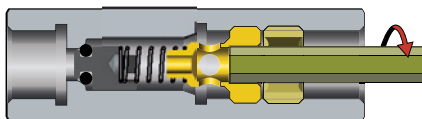

Unscrew the adjustment nut with a smaller Allen key to adjust the cracking pressure. The number of turns adjusts the cracking pressure from 1 bar to 0.10 bar.

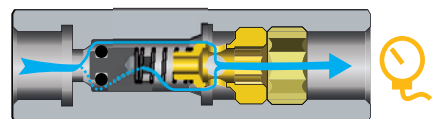

Step 3



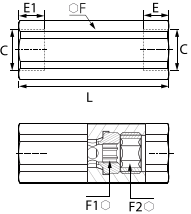

Tighten the locking nut with the Allen key to lock the cracking pressure setting. Then, control the pressure with a pressure gauge downstream.

Nickel-Plated Brass Adjustable Non-Return Valves

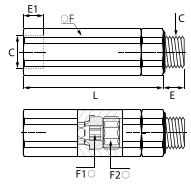

7930 Adjustable Check Valve, Double Female BSPP and Metric Thread

			C	E	E1	F	F1	F2	L	kg	
			M5x0.8	7930 19 19	8	4	13	4	6	49	0.055
			G1/8	7930 10 10	8	6	13	4	6	45	0.033
			G1/4	7930 13 13	10	7.5	16	6	8	54	0.073
			G3/8	7930 17 17	11	8.5	20	8	10	61.5	0.163
			G1/2	7930 21 21	13	10	24	10	12	73	0.171

7931 Adjustable Check Valve Supply, Male/Female BSPP Thread

			C	E	E1	F	F1	F2	L	kg	
			G1/8	7931 10 10	5.5	6	13	4	6	51.5	0.043
			G1/4	7931 13 13	6.5	7.5	16	6	8	61.5	0.208
			G3/8	7931 17 17	7.5	8.5	20	8	10	70	0.125
			G1/2	7931 21 21	9	10	24	10	12	82.5	0.212

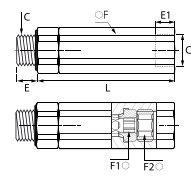
7932 Adjustable Check Valve Exhaust, Male/Female BSPP Thread

			C	E	E1	F	F1	F2	L	kg	
			G1/8	7932 10 10	5.5	8	13	4	6	51.5	0.009
			G1/4	7932 13 13	6.5	10	16	6	8	61.5	0.058
			G3/8	7932 17 17	7.5	11	20	8	10	70	0.123
			G1/2	7932 21 21	9	13	24	10	12	82.5	0.212

LIQUIfit® Non-Return Valves

LIQUIfit® non-return valves meet the requirements for conveying **beverages**. They allow flow in one direction and prevent any return flow. Fitted in the circuit, they provide **total protection**.

Product Advantages

Suitable for Beverage Applications

Fully compatible for use with water, beverages and liquid foodstuffs (liquids and gas)
Very low cracking threshold
Excellent chemical compatibility
Resistant to cleaning products
Hygienic design with smooth surfaces
Fluid direction indicated
EPDM sealing technology



Water Softeners
Water Treatment
Water Purification
Drinks Dispensers
Hot & Cold Water Systems

Applications

Technical Characteristics

Compatible Fluids	Water, beverages, liquid foodstuffs
Working Pressure	1 to 10 bar
Working Temperature	0°C to +65°C
Cracking Pressure	< 0.05 bar

Component Materials

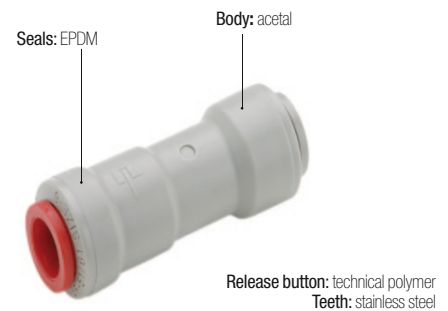

Silicone-free

Regulations

DI: 2002/95/EC (RoHS), 2011/65/EC
FDA: 21 CFR 177.1550
NSF 51 (referenced material)
NSF 61
RG: 1907/2006 (REACH)

LIQUIfit® Non-Return Valves

7992

Single Non-Return Valve



Acetal, EPDM

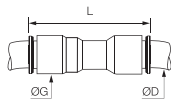

ØD		G	L	kg
1/4	7992 56 00WP2	17	51	0.008
3/8	7992 60 00WP2	20	55	0.011

Associated Products

The full range of LIQUIfit® products can be found in this catalogue:

- Push-in fittings for metric and inch tubing (Chapter 1)
- Valves (Chapter 6)

To complement the LIQUIfit® range, Parker Legris Advanced PE tubing (Chapter 3) is suited to the most demanding environments, approved for permanent contact with beverage and food products, as well as for water treatment.

Stainless Steel Non-Return Valves

Stainless steel non-return valves are ideally suited to **harsh environments** and for conveying **many industrial fluids**. These products allow fluids to flow in one direction and prevent them from flowing in the other.

Product Advantages

Demanding Environments | Robust design
 Suitable for use with many chemicals or in corrosive environments
 Compatible with many fluids

Compact & Versatile | Reduced dimensions
 Smooth external surfaces contribute to equipment cleanliness
 Flow direction symbol protects against incorrect installation
 Hexagonal body to facilitate installation



Applications
 Pneumatics
 Machine Tools
 Food Process
 Printing
 Chemical
 Textile
 Automotive Process

Technical Characteristics

Compatible Fluids	Many fluids
Working Pressure	0.5 to 40 bar
Working Temperature	-20°C to +180°C

Flow Characteristics	Threads	NI/min	Kv
	G1/8	18.88	1.60
G1/4	19.91	1.69	
G3/8	35.54	3.01	
G1/2	36.50	3.10	
G3/4	65.86	5.59	
G1	92.60	7.86	

Cracking Pressure	0.25 bar
--------------------------	----------

Component Materials

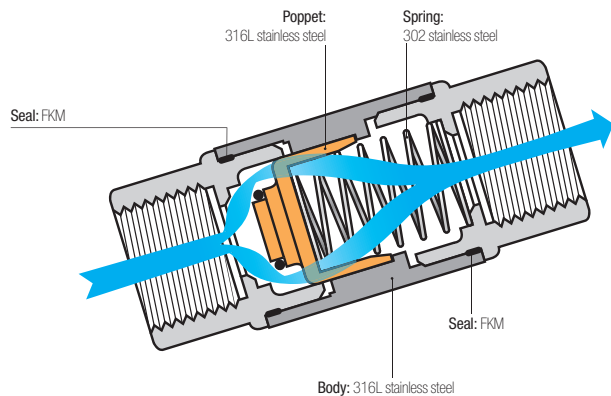

Silicone-free

Regulations

DI: 2002/95/EC (RoHS)
 RG: 1907/2006 (REACH)
 DI: 97/23/EC (PED)

Stainless Steel Non-Return Valves

4890 Non-Return Valve, Female BSPP Thread



Stainless steel 316L, FKM

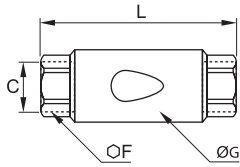

C	DN		F	G	L	kg
G1/8	10	4890 10 10	17	22	50	0.083
G1/4	10	4890 13 13	17	22	50	0.074
G3/8	15	4890 17 17	22	30	67	0.183
G1/2	15	4890 21 21	24	30	71	0.209
G3/4	20	4890 27 27	32	42	84	0.289
G1	25	4890 34 34	38	42	90	0.519

4891 Non-Return Valve, Supply, Male BSPP Thread/Exhaust, Female BSPP Thread



Stainless steel 316L, FKM

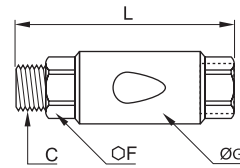

C	DN		F	G	L	kg
G1/8	10	4891 10 10	17	22	56	0.100
G1/4	10	4891 13 13	17	22	58	0.082
G3/8	15	4891 17 17	22	30	75	0.189
G1/2	15	4891 21 21	24	30	79	0.209
G3/4	20	4891 27 27	32	42	84	0.300
G1	25	4891 34 34	38	42	102	0.519

4892 Non-Return Valve, Supply, Female BSPP Thread/Exhaust, Male BSPP Thread



Stainless steel 316L, FKM

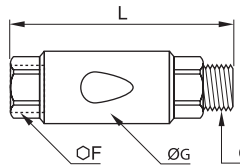

C	DN		F	G	L	kg
G1/8	10	4892 10 10	17	22	56	0.100
G1/4	10	4892 13 13	17	22	58	0.082
G3/8	15	4892 17 17	22	30	75	0.191
G1/2	15	4892 21 21	24	30	79	0.209
G3/4	20	4892 27 27	32	42	84	0.300
G1	25	4892 34 34	38	42	102	0.519

4895 Non-Return Valve, Female NPT Thread



Stainless steel 316L, FKM

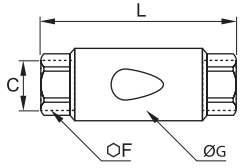

C	DN		F	G	L	kg
NPT1/8	10	4895 11 11	17	22	50	0.083
NPT1/4	10	4895 14 14	17	22	54	0.079
NPT3/8	15	4895 18 18	22	30	67	0.197
NPT1/2	15	4895 22 22	24	30	77	0.194

Soft Start Fittings

These fittings protect your system by preventing sudden shocks. On start-up, they control the **pressure increase** in the downstream circuit; this helps **prevent the risk** of industrial accidents.

Product Advantages

Protection of Equipment & Personnel

- Prevents the risk of damage after any stoppage which requires the system to be vented
- Returns the control valve to its initial position in total safety
- Adjustment of the pressurisation speed
- Protects the adjustment mechanism using a recessed adjustment screw

Mounted on FRL

- Models 7860 and 7861: yellow identification washer
- Protection for the whole system
- Simultaneous pressurisation speed of the whole system

Mounted on Control Valve

- Models 7870 and 7871: black identification washer
- Protection of individual circuits
- Mounted on the control valve, it optimises the pressurisation speed of a specific cylinder



Applications

- Pneumatic Systems
- Robotics
- Textile
- Semi-Conductors
- Packaging
- Pneumatics

Technical Characteristics

Compatible Fluids	Compressed air	
Working Pressure	3 to 10 bar	
Working Temperature	-15°C to +60°C	

Max. Tightening Torques	Threads	daN.m
	G1/4	1.3
G3/8	1.5	
G1/2	1.8	

Flow Characteristics	Model	Flow at 6 bar	Kv
	7860 08 13	1500 NI/min	0.80
7860 10 13	2100 NI/min	1.20	
7860 10 17	2200 NI/min	1.30	
7860 12 17	3100 NI/min	1.00	
7860 12 21	3100 NI/min	1.00	
7861 13 13	2100 NI/min	1.20	
7861 17 17	3100 NI/min	1.00	
7861 21 21	3100 NI/min	1.00	
7870 08 13	1500 NI/min	0.80	
7870 10 13	2000 NI/min	1.15	
7870 10 17	2000 NI/min	1.15	
7871 13 13	2000 NI/min	1.15	
7871 17 17	2000 NI/min	1.15	

Component Materials

Internal seal: NBR

Adjustment screw: nickel-plated brass

Washer: technical polymer

Body: technical polymer or nickel-plated brass

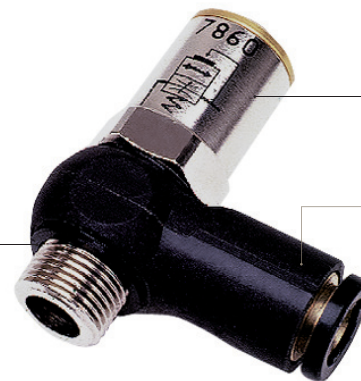

Silicone-free

Regulations

- DI: 2002/95/CE (RoHS)
- RG: 1907/2006 (REACH)
- DI: 97/23/CE (PED)

Operation

Filter, Regulator, Lubricator

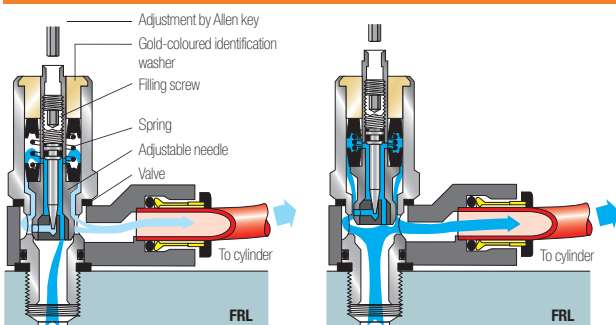

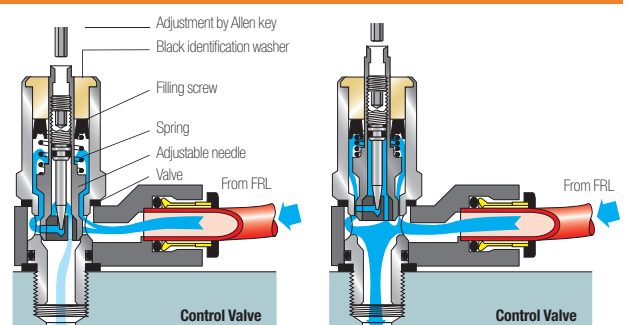

Control Valve



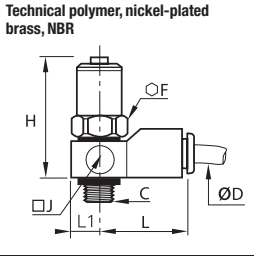

Soft Start Fittings

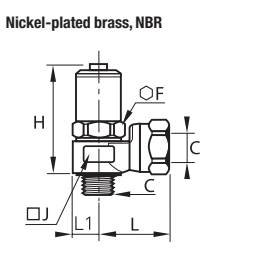

7860 Soft Start Fitting for Isolating Valve, Male BSPP Thread

		Technical polymer, nickel-plated brass, NBR	ØD	C		F	H _{min}	H _{max}	J	L	L1	kg
			8	G1/4	7860 08 13	17	54	61	20	35	10	0.064
			10	G1/4	7860 10 13	22	55	62	25	41	12.5	0.112
				G3/8	7860 10 17	22	55	62	25	41	12.5	0.115
			12	G3/8	7860 12 17	22	55	62	25	45	12.5	0.125
G1/2	7860 12 21	22		63.5	70.5	25	45	12.5	0.152			

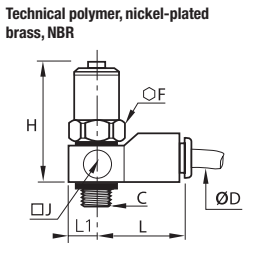

7861 Soft Start Fitting for Isolating Valve, Male/Female BSPP Thread

		Nickel-plated brass, NBR	C		F	H _{min}	H _{max}	J	L	L1	kg
			G1/4	7861 13 13	22	54	62	24	31	12	0.147
			G3/8	7861 17 17	22	55	62	24	31	12	0.139

7870 Soft Start Fitting for Control Valve, Male BSPP Thread

		Technical polymer, nickel-plated brass, NBR	ØD	C		F	H _{min}	H _{max}	J	L	L1	kg
			8	G1/4	7870 08 13	17	54	61	20	35	10	0.066
			10	G1/4	7870 10 13	22	55	62	25	41	12.5	0.114
				G3/8	7870 10 17	22	55	62	25	41	12.5	0.117

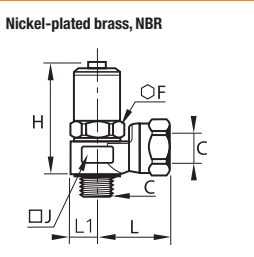
7871 Soft Start Fitting for Control Valve, Male/Female BSPP Thread

		Nickel-plated brass, NBR	C		F	H _{min}	H _{max}	J	L	L1	kg
			G1/4	7871 13 13	22	55	62	24	31	12	0.148
			G3/8	7871 17 17	22	55	62	24	31	12	0.141

Adjustment of the Filling Screw

Adjusting the screw to regulate the flow of air optimises the time taken to pressurise depending on the air volume to be refilled and the system requirements.

To adjust:

- immobilise the piston using a spanner
- adjust the screw with an Allen key
 - 1.5 mm key for 8 mm diameter
 - 2.5 mm key for 10 and 12 mm diameter

Max. tightening torque: 0.1 daN.m

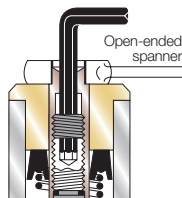

Cylinder Pressure Cycle

When the downstream pressure reaches 2/3 of the supply pressure, full flow is automatically established

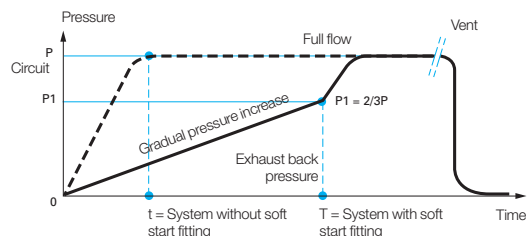

Pneumatic Sensor Fittings

The sensor detects the pressure drop when a cylinder reaches the end of its stroke. They produce a **pneumatic or electric output signal** when the pressure drop in the exhaust chamber of the cylinder goes below their back pressure threshold.

Product Advantages

Easy-to-Use | Suited to changes of series: no adjustment to position detectors is necessary

With Pneumatic Output | Totally pneumatic installation
 2 possible installations:

- Supplied with permanent pressure (P1): produces a pneumatic signal when the back pressure threshold is reached
- Supplied from the control valve-cylinder circuit on the opposite side: no unexpected pneumatic signal (S) can appear during pressurisation due to the actuating pressure which supplies the sensor fitting (P1)

With Electrical Output | Combined electrical and pneumatic installation
 Installation with continuous electrical supply only (BU)
 Guarantees an electrical signal when the back pressure threshold is reached



Applications
 Robotics
 Textile
 Semi-Conductors
 Packaging
 Pneumatics

Technical Characteristics

Compatible Fluids	Compressed air
Working Pressure	3 to 8 bar
Working Temperature	-15°C to +60°C
Back Pressure	0.85 to 1 bar
Switching Time	Model 7818: 3 ms
Open/Closed Contact	Model 7828: 2A / 0-48 V 2A / 250 V 50 Hz

Component Materials

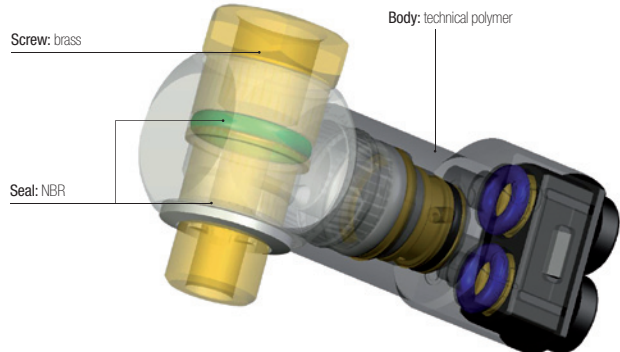

Silicone-free

Regulations

DI: 2002/95/EC (RoHS)
 RG: 1907/2006 (REACH)
 DI: 97/23/EC (PED)

Operation

Pneumatic Installation Diagram

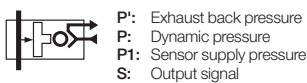

Electrical Installation Diagram

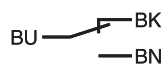

Connection via 3 core 0.5 mm² cable, 2 meters long.
 Contactor: 5A / 250 V ~ or 5W / 48V =

Cylinder in Operation

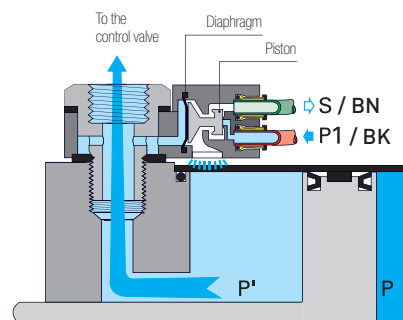

Cylinder in Final Position

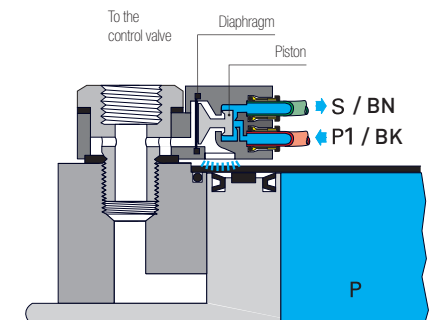

Pneumatic Sensor Fittings

7818 Pneumatic Sensor Fitting, Male BSPP and Metric Thread



Technical polymer, zamak, brass, NBR

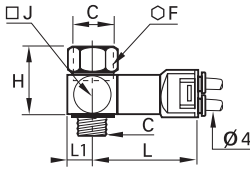

ØD	C		F	H	J	L	L1	kg
M5x0.8	7818 04 19*		8	16	11	43.5	5.5	0.025
G1/8	7818 04 10		14	23	16	44.5	8	0.043
G1/4	7818 04 13		17	28	19.5	46.5	10	0.061
G3/8	7818 04 17		22	29	23.5	49	12	0.083
G1/2	7818 04 21		27	30	31.5	52.5	16	0.125

* Bolt zinc passivated steel

7818 Pneumatic Sensor, Male/Female BSPP Thread



Technical polymer, zamak, brass, NBR

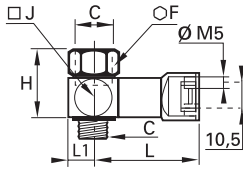

C		F	H	J	L	L1	kg
G1/8	7818 19 10	14	23	16	40.5	8	0.047
G1/4	7818 19 13	17	28	19.5	42.5	10	0.065

7828 Pneumatic/Electric Sensor, Male/Female BSPP and Metric Thread



Technical polymer, brass, NBR

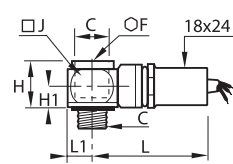

C		F	H	H1	J	L	L1	kg
M5x0.8	7828 00 19	8	20	10	11	49	5.5	0.120
G1/8	7828 00 10	6	20	10	16	52	8	0.131
G1/4	7828 00 13	8	20	10	21	54	10.5	0.145
G3/8	7828 00 17	10	22	12	28	57	14	0.182
G1/2	7828 00 21	12	26	14	33	58	16.5	0.206

Cylinder Pressure Cycle

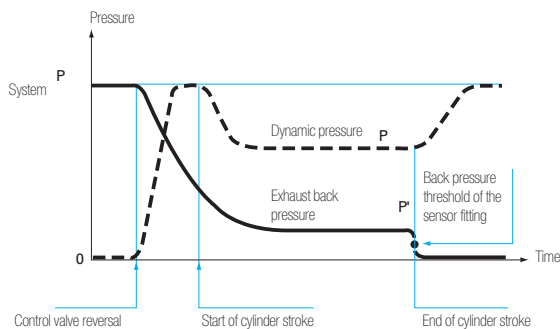

Installation Diagram

Depending on model, S1, S2 and P1 may be pneumatic or electric. See the installation diagrams opposite.

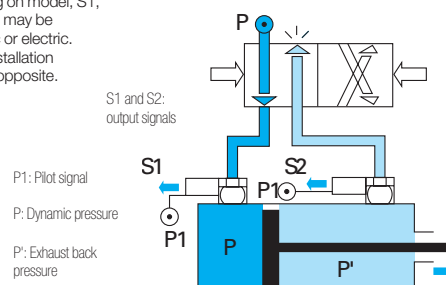

Pressure Regulators

Parker Legris pressure regulators **stabilise at the maximum determined value** the pressure delivered to the pneumatic equipment, whatever the fluctuations of the pressure upstream.

Product Advantages

Ergonomics | Easy adjustment of the output pressure through the knurled screw
 Lockable adjustment possible
 Output pressure adjustment options marked on the screw

Energy Savings | Setting of the optimum pressure enables the equipment to function correctly
 Installation in a manifold allows optimum output pressures to be delivered to specific parts of the circuit
 Designed for applications where cylinder force needs to be controlled: marking, sleeving, crimping cylinders etc.



Applications
 Robotics
 Textile
 Semi-Conductors
 Packaging
 Pneumatics

Technical Characteristics

Compatible Fluids	Compressed air		
Working Pressure	Upstream pressure: 1 to 16 bar Downstream pressure: 1 to 8 bar		
Working Temperature	-10°C to +70°C		

Max. Tightening Torques	Threads	G1/8	G1/4	G3/8
	daN.m	0.4	0.5	0.6

Component Materials



Silicone-free

Regulations

DI: 2002/95/EC (RoHS)
 RG: 1907/2006 (REACH)
 DI: 97/23/EC (PED)

Operation

Mounting Upstream of the Control Valve

Adjustment of the piston feed pressure in both directions

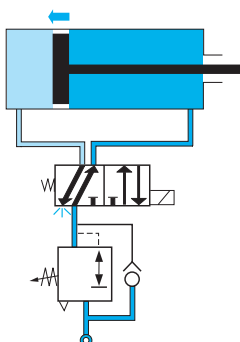

Mounting Downstream of the Control Valve

Phase 1: adjustment of the piston speed in a single direction

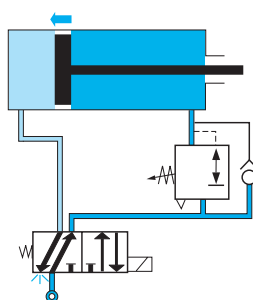

Phase 2: in return direction, pressure is supplied through the control valve

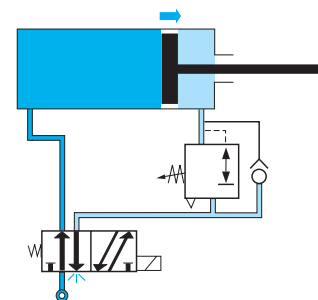

Pressure Regulators

7300

Pressure Regulator, Male BSPP Thread



Technical polymer, nickel-plated brass, NBR

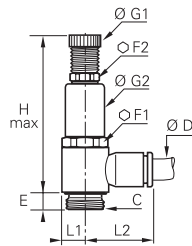

ØD	C		E	F1	F2	G1	G2	H _{max}	L1	L2	kg
4	G1/8	7300 04 10	4.5	17	13	14	17	65	7	18.5	0.047
	G1/8	7300 06 10	4.5	17	13	14	17	65	7	20	0.047
6	G1/4	7300 06 13	7.5	17	13	14	17	74.5	9.5	22	0.065
	G1/8	7300 08 10	4.5	17	13	14	17	65	7	25	0.048
8	G1/4	7300 08 13	7.5	17	13	14	17	74.5	9.5	27	0.066
	G3/8	7300 08 17	8.5	22	17	18.5	22	84	11.5	28.5	0.121
10	G1/4	7300 10 13	7.5	17	13	14	17	74.5	9.5	29	0.067
	G3/8	7300 10 17	8.5	22	17	18.5	22	84	11.5	30.5	0.122

Flow Characteristics at 7 bar (NI/min)

G1/8 Models

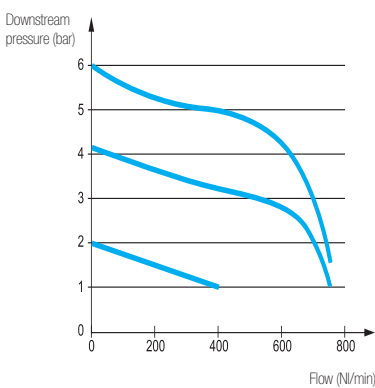

G1/4 Models

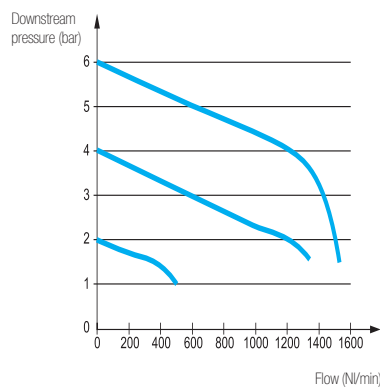

G3/8 Models

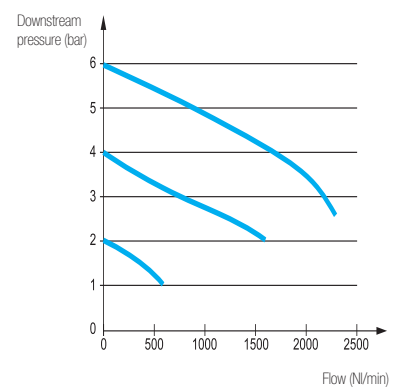

Pressure Reducers

Parker Legris pressure reducers are designed to **set the pressure** of a compressed air circuit to a determined value. They therefore enable **energy saving** by limiting the cylinder pressure.

Product Advantages

Design & Performance

- Optimisation of the pressure at the minimum values required to provide final force and energy consumption
- Manual adjustment protected by a plug
- Visual indication of the differential pressure by colour code

Two Models Available

- Banjo: fitted directly on the control valve or terminal block
- In-line: fitted in the pipework, between the control valve and cylinder



Applications

- Robotics
- Textile
- Semi-Conductors
- Packaging
- Pneumatics

Technical Characteristics

Compatible Fluids	Compressed air				
Working Pressure	1 to 8 bar				
Working Temperature	-15°C to +60°C				
Max. Tightening Torques for Models 7318 and 7471	Threads	G1/8	G1/4	G3/8	G1/2
	daN.m	0.8	1.2	3	3.5

Component Materials

Internal seals: NBR



Screw: nickel-plated brass

Sealing washer: technical polymer

Body: Models 7318-7471: zamak
Models 7316-7416: nickel-plated, shot-blasted brass

Silicone-free

Regulations

- DI: 2002/95/EC (RoHS)
- RG: 1907/2006 (REACH)
- DI: 97/23/EC (PED)

Operation

Installation Diagram

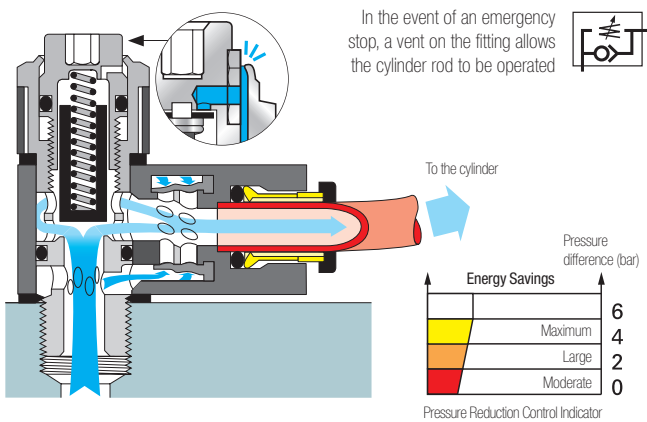

Cylinder Pressure Cycle

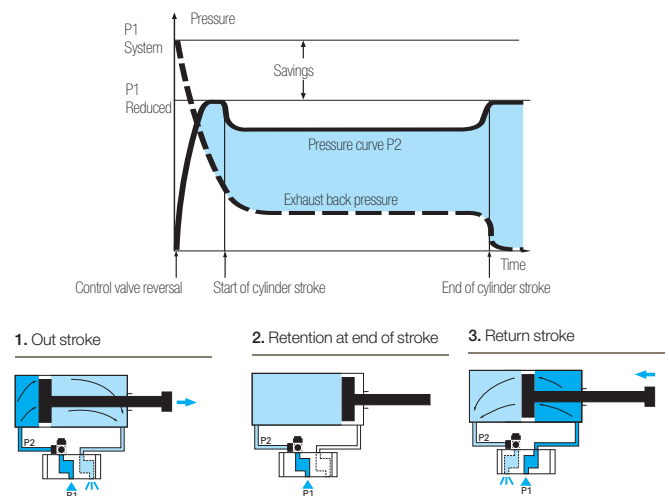

Manual Adjustment

To ease access to the adjustment, Parker Legris has designed a plug-in manual control system.

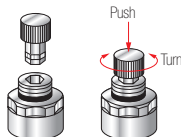

To prevent access to the setting mechanism, a sealing plug may be used.

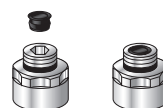

This may be removed if necessary as follows:
1. Pierce the centre
2. Remove the plug



Pressure Reducers

7318 Banjo Pressure Reducer, Male BSPP Thread



Zamak, nickel-plated brass, NBR

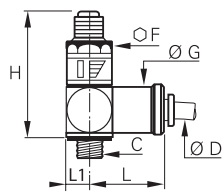

ØD	C		F	G	H _{min}	H _{max}	L	L1	kg
6	G1/8	7318 06 10	19	20	49	57	43	10.5	0.137
	G1/4	7318 06 13	19	20	49	57	43	10.5	0.137
8	G1/4	7318 08 13	19	20	49	57	40	10.5	0.134
	G1/4	7318 10 13	27	20	55	64	50	14	0.251
10	G3/8	7318 10 17	27	26	55	94	50	14	0.253

7471 Banjo Pressure Reducer, Male/Female BSPP Thread



Zamak, nickel-plated brass, NBR

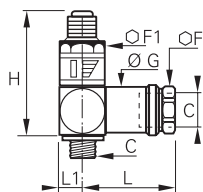

C		F	F1	G	H _{min}	H _{max}	L	L1	kg
G1/8	7471 10 10	19	19	20	49	57	45	10.5	0.158
G1/4	7471 13 13	19	19	20	49	57	45	10.5	0.149
G3/8	7471 17 17	24	27	26	55	64	56	14	0.290
G1/2	7471 21 21	30	30	31	75	86	63	16.5	0.502

7316 In-Line Tube-to-Tube Pressure Reducer



Nickel-plated brass, NBR

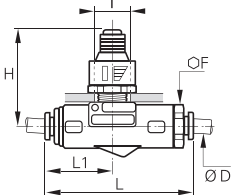

ØD		F	H _{min}	H _{max}	L	L1	ØT	kg
6	7316 06 00	22	49	57	74	32	18.5	0.212
8	7316 08 00	22	49	57	71	32	18.5	0.200
10	7316 10 00	27	61	70	89	41	22.5	0.412

7416 In-Line Pressure Reducer, Female BSPP Thread



Nickel-plated brass, NBR

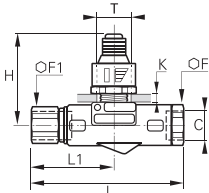

C		F	F1	H _{min}	H _{max}	K	L	L1	ØT	kg
G1/8	7416 10 10	17	19	49	57	4	74	35	18.5	0.212
G1/4	7416 13 13	17	19	49	57	4	83	44	18.5	0.214
G3/8	7416 17 17	22	27	61	70	5	90	44	22.5	0.401
G1/2	7416 21 21	27	30	75	86	7	119	61	22.5	0.651

7000 Sealing Plug for Pressure Reducer



Technical polymer



	G	kg
7000 00 01	8	0.001

7000 Manual Ratchet Control for Pressure Reducer



Nickel-plated brass, NBR

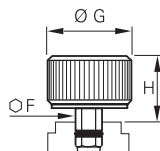

	F	G	H	kg
7000 00 00	6	22	15	0.040

Snap Fittings

The snap fittings enable a **circuit to be isolated** without the need to vent the complete system. They are designed to facilitate repeated connections and disconnections in total safety.



Product Advantages

Performance & Safety

- Partial venting of systems while work is carried out
- Energy and time saving during maintenance operations
- Protection of individuals by maintaining pressure if necessary
- Audible click indicates connection
- Circuit identification by coloured rings (on request)

Applications

- Control Panels
- Robotics
- Semi-Conductors
- Packaging
- Pneumatics
- Automotive Process

Technical Characteristics

Compatible Fluids	Compressed air
Working Pressure	0 to 10 bar
Working Temperature	-20°C to +80°C
Flow Characteristics at 6 bar	DN 5 mm: 1000 NI/min DN 7 mm: 1900 NI/min

Regulations

- DI: 2002/95/EC (RoHS)
- RG: 1907/2006 (REACH)
- DI: 97/23/EC (PED)

Component Materials

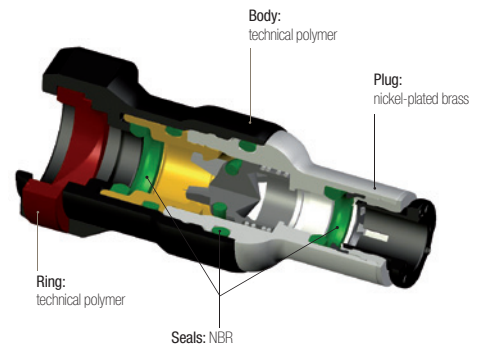

Silicone-free

Operation

Circuit Closed

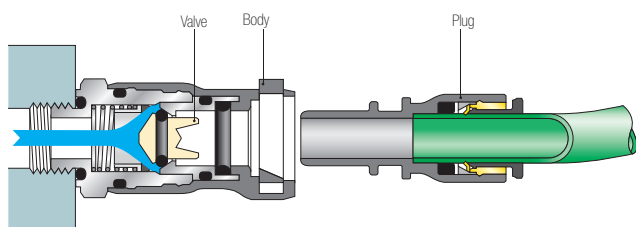

Circuit Open

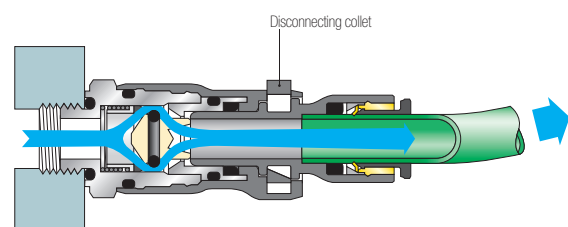

Flow Characteristics - Pressure Drop

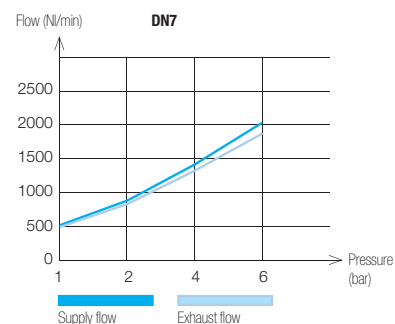
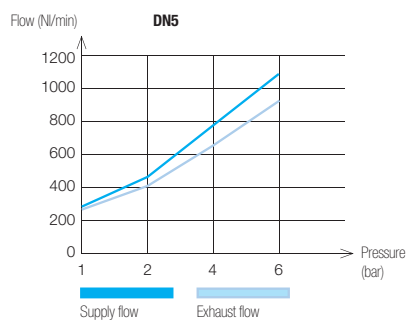

Snap Fittings

7926 Body with Push-In Connection



Technical polymer, nickel-plated brass, NBR

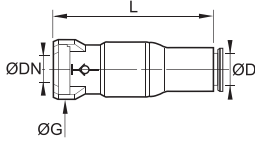

ØD	DN		G	L	kg
6	5	7926 05 06	18.5	44	0.020
8	5	7926 05 08	18.5	49	0.024
10	7.3	7926 07 10	22	58.5	0.044

7921 Body with Male BSPP Thread



Technical polymer, nickel-plated brass, NBR

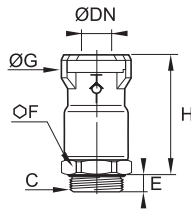

C	DN		E	F	G	H	kg
G1/8	5	7921 05 10	5.5	16	18.5	31.5	0.022
G1/4	5	7921 05 13	5.5	16	18.5	31.5	0.023
G1/4	7.3	7921 07 13	5.5	20	22	37.5	0.039
G3/8	7.3	7921 07 17	5.5	20	22	37.5	0.041

7960 Straight Probe, Push-In Connection



Technical polymer, NBR

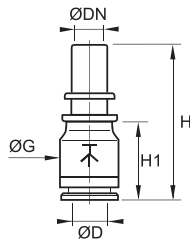

ØD	DN		G	H	H1	kg
6	5	7960 05 06	13.5	36.5	17.5	0.007
8	5	7960 05 08	13.5	37	18	0.003
10	7.3	7960 07 10	16	41	20.5	0.004

7961 Straight Probe, Male BSPP Thread



Technical polymer, nickel-plated brass, NBR

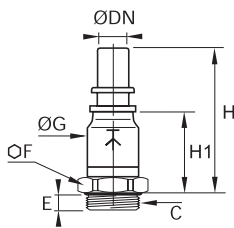

C	DN		E	F	G	H	H1	kg
G1/8	5	7961 05 10	5.5	13	13.5	46	27	0.017
G1/4	5	7961 05 13	5.5	16	13.5	46	27	0.019
G1/4	7.3	7961 07 13	5.5	16	16	51.5	31	0.025
G3/8	7.3	7961 07 17	5.5	20	16	51.5	31	0.034

Manually-Operated Valves

Manually-operated valves offer a **reliable** and **durable** system for opening and closing the circuit when the system has to be **switched frequently**. They provide a significant reduction in the time needed to work on pneumatic circuits.

Product Advantages

Manual Switch-Operated Valves

Downstream control supply provided by simply moving the lever
 2 models available to provide the best solution for the system:

- 3/2: opening, closing, venting
- 2/2: opening, closing

Compact and ergonomic (can be positioned through 360°)
 Push-in connections

Valves with Sliding Sleeve

Uni-directional use ensures the downstream circuit is vented
 Operated in the plane of the tube
 Lightweight due to the use of aluminium
 Ideal for complex installations in a restricted space
 Immediate identification of the venting system by the colour (red)



Applications

Robotics
 Conveyors
 Textile
 Plastics Engineering
 Printing
 Pneumatics
 Packaging

Technical Characteristics

Compatible Fluids	Compressed air
Working Pressure	0 to 10 bar Model 0669: 0 to 16 bar
Working Temperature	-10°C to +80°C Model 0669: -5°C to +70°C

Component Materials

Seals: NBR

Bolt:

Manual switch-operated valve: nickel-plated brass with seal
 Sleeve valve: nickel-plated brass

Body:

Manual switch-operated valve: technical polymer
 Sleeve valve: nickel-plated brass

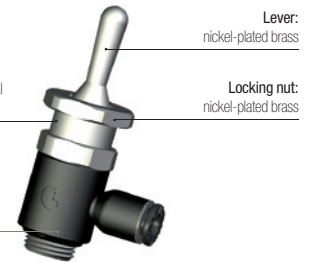

Silicone-free

Regulations

DI: 2002/95/EC (RoHS)
 RG: 1907/2006 (REACH)
 DI: 97/23/EC (PED)

Operation

Switch-Operated Valves



Open

Closed

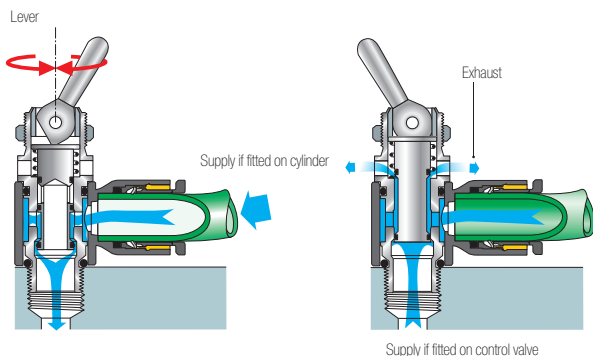

Sleeve Valves

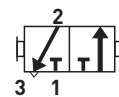

Open: downstream supply

Closed: downstream exhaust

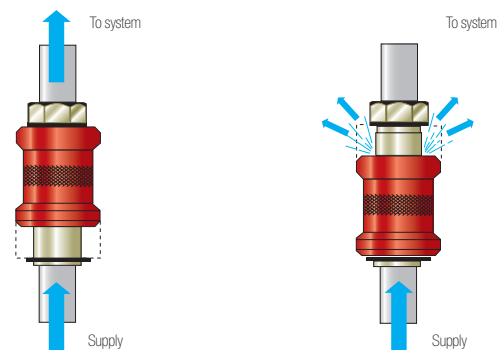

Manually-Operated Valves

7800

3/2 Manual Switch-Operated Valve, Supply, Male BSPP and Metric Thread



Technical polymer, nickel-plated brass, NBR

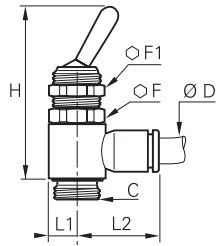

ØD	C		F	F1	H	L1	L2	kg
4	M5x0.8	7800 04 19	14	14	42	7	18.5	0.008
	G1/8	7800 04 10	14	14	43	7	18.5	0.022
6	M5x0.8	7800 06 19	14	14	42	7	18.5	0.009
	G1/8	7800 06 10	14	14	43	7	20	0.023
8	G1/4	7800 08 10	17	14	50.5	9	22	0.048
	G1/8	7800 08 10	14	14	43	7	25	0.023
10	G1/4	7800 10 13	17	14	50.5	9	29	0.048

For part numbers 7800 04 19 and 7800 06 19, adaptor sealing is effected by a flat PTFE seal and tightening torque is maximum 0.16 daN.m.

7801

3/2 Manual Switch-Operated Valve, Control, Male BSPP Thread



Technical polymer, nickel-plated brass, NBR

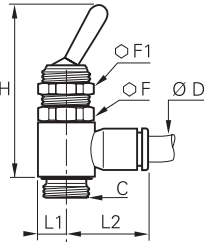

ØD	C		F	F1	H	L1	L2	kg
4	G1/8	7801 04 10	14	14	43	7	18.5	0.023
6	G1/8	7801 06 10	14	14	43	7	20	0.023
	G1/4	7801 06 13	17	14	50.5	9	22	0.048
8	G1/8	7801 08 10	14	14	43	7	25	0.026
	G1/4	7801 08 13	17	14	50.5	9	27	0.049
10	G1/4	7801 10 13	17	14	50.5	9	29	0.051

7802

2/2 Manual Switch-Operated Valve, Male BSPP Thread



Technical polymer, nickel-plated brass, NBR

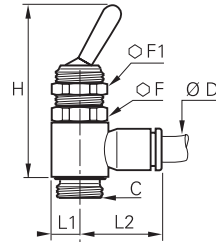

ØD	C		F	F1	H	L1	L2	kg
4	G1/8	7802 04 10	14	14	43	7	18.5	0.023
	G1/8	7802 06 10	14	14	43	7	20	0.024
6	G1/4	7802 06 13	17	14	50.5	9	22	0.050
	G1/8	7802 08 10	14	14	43	7	25	0.024
8	G1/4	7802 08 13	17	14	50.5	9	27	0.052
	G1/4	7802 10 13	17	14	50.5	9	29	0.052

0669

3/2 Sleeve Valve, Female BSPP and Metric Thread



Nickel-plated brass, aluminium, NBR

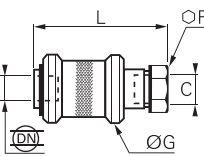

C	DN		F	G	L	kg
M5x0.8	2.5	0669 02 19	10	14	30.5	0.012
G1/8	4	0669 04 10	14	25	48	0.050
G1/4	7	0669 07 13	19	30	58	0.096
G3/8	10	0669 10 17	22	35	68	0.154
G1/2	14	0669 14 21	27	40	75	0.210
G3/4	19	0669 19 27	32	50	83	0.324

Metal Quick Exhaust Valves

This range of metal quick exhaust valves is offered in nickel-plated brass, aluminium and stainless steel. These valves, which are suitable for **any environment**, increase the **return speed** of the cylinder rod by allowing the exhaust to pass directly to atmosphere.

Product Advantages

Time Saving & Compact

Reduction in cycle times: return speed improved
Dimensions optimised for space reduction
Exhaust silencer incorporated on some models
Excellent exhaust capacity
Robust

Nickel-Plated Brass or Stainless Steel

Ideal for applications in restrictive environments
Orientation as required
Many installation options and choice of silencer
Designed without retention areas to optimise frequent cleaning operations (stainless steel)

Aluminium

Protection of individuals through low noise emissions
Lightweight and robust
Silencer integrated for greater compactness



Applications

- Robotics
- Conveyors
- Textile
- Plastics Engineering
- Printing
- Pneumatics
- Packaging

Technical Characteristics

Compatible Fluids	Compressed air
Working Pressure	7970: 0.7 to 10 bar 7971 and 7899: 2 to 10 bar
Working Temperature	7970: -20°C to +70°C 7971: -10°C to +70°C 7899: Threads G1/8 and G1/4: -10°C to +120°C Threads G3/8 to G1: -20°C to +180°C

Component Materials

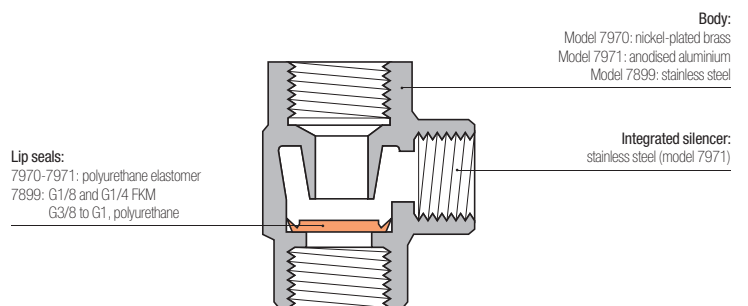

Silicone-free

Regulations

DI: 2002/95/EC (RoHS)
RG: 1907/2006 (REACH)
DI: 97/23/EC (PED)

Operation

Mounted on Cylinder

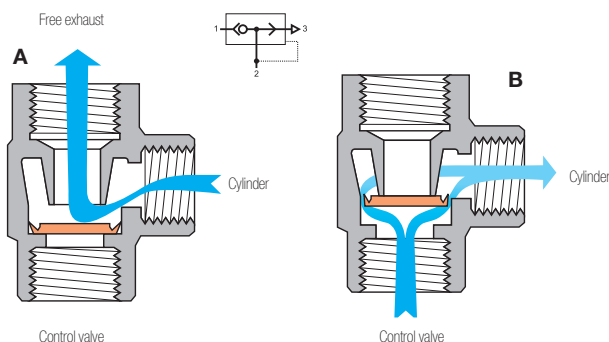

Installation Diagram

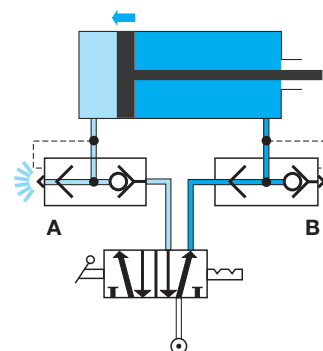

Metal Quick Exhaust Valves

7970

Elbow Quick Exhaust Valve, Female BSPP and Metric Thread



Nickel-plated brass

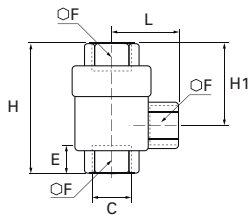

C		E	F	H	H1	L	kg
M5x0.8	7970 19 19	5	10	24.8	15.6	4	0.028
G1/8	7970 10 10	7.5	14	42	28	8	0.084
G1/4	7970 13 13	11	19	53	34.5	11	0.146
G3/8	7970 17 17	12	21	58	36	12	0.149
G1/2	7970 21 21	14	26	71	44	14	0.314
G3/4	7970 27 27	16	32	86	52	18	0.449
G1	7970 34 34	19	38	94	56	19	0.530

Noise level:
7971 10 10 : 70 dBa
7971 13 13 : 70 dBa
7971 17 17 : 72 dBa
7971 21 21 : 88 dBa

7971

Elbow Quick Exhaust Valve, Male BSPT/Female BSPP Thread



Treated aluminium

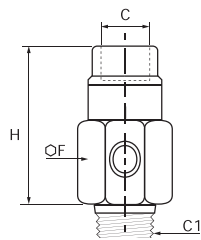

C	C1		F	H	kg
G1/8	R1/8	7971 10 10	18	51	0.013
G1/4	R1/4	7971 13 13	18	49	0.018
G3/8	R3/8	7971 17 17	27	56	0.048
G1/2	R1/2	7971 21 21	34	70	0.086

7899

Quick Exhaust Valve, Female BSPP Thread



Stainless steel 316L

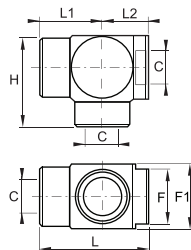

C	DN		F	F1	H	L	L1	L2	kg
G1/8	7	7899 00 10	17	22	31.5	37.5	21	16.5	0.097
G1/4	7	7899 00 13	17	22	31.5	37.5	21	16.5	0.083
G3/8	9	7899 00 17	22	26	37	44.5	25.5	19	0.139
G1/2	12	7899 00 21	27	32	45	54	31	23	0.240
G3/4	18	7899 00 27	38	46	65	79	44	35	0.795
G1	18	7899 00 34	38	46	65	79	44	35	0.674

To complement our exhaust valves 7970 and 7899, you will find a full range of silencers on the following pages.

Silencers

Silencers are designed for installation on exhaust circuits **to reduce the noise levels** of equipment while operating, thus improving user comfort.

Product Advantages

Variety of Applications

- 2 versions incorporating flow control regulation
- Extremely compact models available
- Polyethylene: excellent balance between exhaust flow rate and noise reduction
- Sintered bronze: robust and economic
- 316L stainless steel: increased chemical resistance and mechanical strength



Robotics
Textile
Semi-Conductors
Packaging
Pneumatics

Applications

Technical Characteristics

Compatible Fluids	Compressed air
Working Pressure	Polyethylene: 0 to 10 bar Sintered bronze: 0 to 12 bar 316L stainless steel: 0 to 12 bar
Working Temperature	Polyethylene: -10°C to +80°C Sintered bronze: -20°C to +150°C 316L stainless steel: -20°C to +180°C

Component Materials

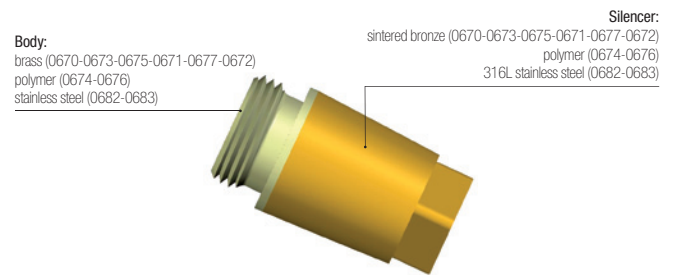

Silicone-free

Regulations

- DI: 2002/95/EC (RoHS)
- RG: 1907/2006 (REACH)
- DI: 97/23/EC (PED)
- DI: 2003/10/EC (Noise Directive)
- Requirement to use ear protection if exposure > 8 hours (85 dBA)
- RG: 1910.95(b) (OSHA)
- Requirement to use ear protection if exposure > 8 hours (90 dBA)



Flow and Noise Levels for Silencers 0672 and 0676

0672	Number of Turns						Noise Level in dBA at 6 bar and 350 NI/min
	0	1	2	3	4	5	
0672 00 10	0	200	600	740	-	-	81
0672 00 13	0	300	650	1280	-	-	82
0672 00 17	0	450	950	1300	1500	-	83
0672 00 21	0	830	1430	1800	2100	2220	83

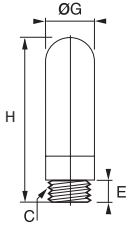

0676	Number of Turns										Noise Level in dBA at 6 bar and 350 NI/min
	0	1	2	3	4	5	6	7	8	9	
0676 00 10	0	30	90	210	335	370	390	390	395	395	82
0676 00 13	0	22	25	50	340	750	940	980	1000	1025	84
0676 00 19	0	22	69	97	125	143	-	-	-	-	81
0676 00 17	0	518	1147	1716	2153	2571	2823	2930	-	-	85
0676 00 21		814	1849	2880	4087	5044	5236	-	-	-	86

Silencers

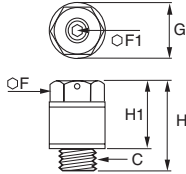

0674 Polymer Silencer, Male BSPP and Metric Thread

	<p>Technical polymer</p> 	<p>C </p>	E	G	H	kg																																								
		<table border="1"> <tr><td>M5x0.8</td><td>0674 00 19</td><td>4</td><td>6.5</td><td>23</td><td>0.003</td></tr> <tr><td>G1/8</td><td>0674 00 10</td><td>6</td><td>12.5</td><td>34</td><td>0.002</td></tr> <tr><td>G1/4</td><td>0674 00 13</td><td>7</td><td>15.5</td><td>42.5</td><td>0.003</td></tr> <tr><td>G3/8</td><td>0674 00 17</td><td>11.5</td><td>18.5</td><td>67.5</td><td>0.007</td></tr> <tr><td>G1/2</td><td>0674 00 21</td><td>11</td><td>23.5</td><td>78</td><td>0.010</td></tr> <tr><td>G3/4</td><td>0674 00 27</td><td>15.5</td><td>38.5</td><td>131</td><td>0.035</td></tr> <tr><td>G1</td><td>0674 00 34</td><td>19.5</td><td>49</td><td>160</td><td>0.056</td></tr> </table>	M5x0.8	0674 00 19	4	6.5	23	0.003	G1/8	0674 00 10	6	12.5	34	0.002	G1/4	0674 00 13	7	15.5	42.5	0.003	G3/8	0674 00 17	11.5	18.5	67.5	0.007	G1/2	0674 00 21	11	23.5	78	0.010	G3/4	0674 00 27	15.5	38.5	131	0.035	G1	0674 00 34	19.5	49	160	0.056		
M5x0.8	0674 00 19	4	6.5	23	0.003																																									
G1/8	0674 00 10	6	12.5	34	0.002																																									
G1/4	0674 00 13	7	15.5	42.5	0.003																																									
G3/8	0674 00 17	11.5	18.5	67.5	0.007																																									
G1/2	0674 00 21	11	23.5	78	0.010																																									
G3/4	0674 00 27	15.5	38.5	131	0.035																																									
G1	0674 00 34	19.5	49	160	0.056																																									

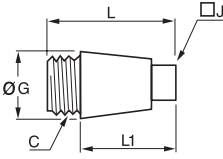

0676 Flow Control Polymer Silencer, Male BSPP and Metric Thread

	<p>Technical polymer</p> 	<p>C </p>	F	F1	G	H	H1	kg																																					
		<table border="1"> <tr><td>M5x0.8</td><td>0676 00 19</td><td>8</td><td>1.5</td><td>9.2</td><td>16</td><td>11</td><td>0.008</td></tr> <tr><td>G1/8</td><td>0676 00 10</td><td>13</td><td>2.5</td><td>15</td><td>20.5</td><td>14.5</td><td>0.003</td></tr> <tr><td>G1/4</td><td>0676 00 13</td><td>15</td><td>4</td><td>18</td><td>29</td><td>22</td><td>0.007</td></tr> <tr><td>G3/8</td><td>0676 00 17</td><td>20</td><td>6</td><td>24</td><td>38</td><td>30</td><td>0.018</td></tr> <tr><td>G1/2</td><td>0676 00 21</td><td>25</td><td>8</td><td>30</td><td>50</td><td>40</td><td>0.045</td></tr> </table>	M5x0.8	0676 00 19	8	1.5	9.2	16	11	0.008	G1/8	0676 00 10	13	2.5	15	20.5	14.5	0.003	G1/4	0676 00 13	15	4	18	29	22	0.007	G3/8	0676 00 17	20	6	24	38	30	0.018	G1/2	0676 00 21	25	8	30	50	40	0.045			
M5x0.8	0676 00 19	8	1.5	9.2	16	11	0.008																																						
G1/8	0676 00 10	13	2.5	15	20.5	14.5	0.003																																						
G1/4	0676 00 13	15	4	18	29	22	0.007																																						
G3/8	0676 00 17	20	6	24	38	30	0.018																																						
G1/2	0676 00 21	25	8	30	50	40	0.045																																						

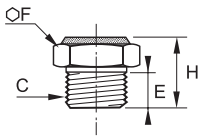

0670 Threaded Silencer, Male BSPP Thread

	<p>Sintered bronze, brass</p> 	<p>C </p>	G	J	L	L1	kg																																								
		<table border="1"> <tr><td>G1/8</td><td>0670 00 10</td><td>12</td><td>7</td><td>22</td><td>17</td><td>0.007</td></tr> <tr><td>G1/4</td><td>0670 00 13</td><td>15</td><td>9</td><td>27</td><td>21</td><td>0.015</td></tr> <tr><td>G3/8</td><td>0670 00 17</td><td>19</td><td>11</td><td>35</td><td>28</td><td>0.028</td></tr> <tr><td>G1/2</td><td>0670 00 21</td><td>23</td><td>13</td><td>43</td><td>34</td><td>0.049</td></tr> <tr><td>G3/4</td><td>0670 00 27</td><td>30</td><td>17</td><td>55</td><td>45</td><td>0.091</td></tr> <tr><td>G1</td><td>0670 00 34</td><td>37</td><td>21</td><td>65</td><td>53</td><td>0.152</td></tr> </table>	G1/8	0670 00 10	12	7	22	17	0.007	G1/4	0670 00 13	15	9	27	21	0.015	G3/8	0670 00 17	19	11	35	28	0.028	G1/2	0670 00 21	23	13	43	34	0.049	G3/4	0670 00 27	30	17	55	45	0.091	G1	0670 00 34	37	21	65	53	0.152			
G1/8	0670 00 10	12	7	22	17	0.007																																									
G1/4	0670 00 13	15	9	27	21	0.015																																									
G3/8	0670 00 17	19	11	35	28	0.028																																									
G1/2	0670 00 21	23	13	43	34	0.049																																									
G3/4	0670 00 27	30	17	55	45	0.091																																									
G1	0670 00 34	37	21	65	53	0.152																																									

0673 Compact Silencer, Male BSPP and Metric Thread

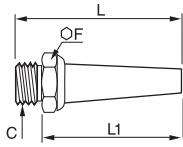

	<p>Sintered bronze, brass</p> 	<p>C </p>	E	F	H	kg																												
		<table border="1"> <tr><td>M5x0.8</td><td>0673 00 19</td><td>4</td><td>7</td><td>8</td><td>0.001</td></tr> <tr><td>G1/8</td><td>0673 00 10</td><td>8</td><td>14</td><td>14</td><td>0.008</td></tr> <tr><td>G1/4</td><td>0673 00 13</td><td>8</td><td>17</td><td>14</td><td>0.012</td></tr> <tr><td>G3/8</td><td>0673 00 17</td><td>10</td><td>22</td><td>18</td><td>0.020</td></tr> <tr><td>G1/2</td><td>0673 00 21</td><td>12</td><td>27</td><td>21</td><td>0.042</td></tr> </table>	M5x0.8	0673 00 19	4	7	8	0.001	G1/8	0673 00 10	8	14	14	0.008	G1/4	0673 00 13	8	17	14	0.012	G3/8	0673 00 17	10	22	18	0.020	G1/2	0673 00 21	12	27	21	0.042		
M5x0.8	0673 00 19	4	7	8	0.001																													
G1/8	0673 00 10	8	14	14	0.008																													
G1/4	0673 00 13	8	17	14	0.012																													
G3/8	0673 00 17	10	22	18	0.020																													
G1/2	0673 00 21	12	27	21	0.042																													

0675 Threaded Silencer, Male BSPP and Metric Thread

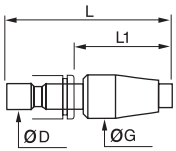

	<p>Sintered bronze, brass</p> 	<p>C </p>	F	L	L1	kg																																		
		<table border="1"> <tr><td>M5x0.8</td><td>0675 00 19</td><td>7</td><td>16</td><td>12</td><td>0.002</td></tr> <tr><td>M7x1</td><td>0675 00 55</td><td>11</td><td>25</td><td>19</td><td>0.005</td></tr> <tr><td>G1/8</td><td>0675 00 10</td><td>14</td><td>42</td><td>34</td><td>0.014</td></tr> <tr><td>G1/4</td><td>0675 00 13</td><td>17</td><td>52</td><td>44</td><td>0.022</td></tr> <tr><td>G3/8</td><td>0675 00 17</td><td>22</td><td>54</td><td>44</td><td>0.037</td></tr> <tr><td>G1/2</td><td>0675 00 21</td><td>27</td><td>65</td><td>53</td><td>0.072</td></tr> </table>	M5x0.8	0675 00 19	7	16	12	0.002	M7x1	0675 00 55	11	25	19	0.005	G1/8	0675 00 10	14	42	34	0.014	G1/4	0675 00 13	17	52	44	0.022	G3/8	0675 00 17	22	54	44	0.037	G1/2	0675 00 21	27	65	53	0.072		
M5x0.8	0675 00 19	7	16	12	0.002																																			
M7x1	0675 00 55	11	25	19	0.005																																			
G1/8	0675 00 10	14	42	34	0.014																																			
G1/4	0675 00 13	17	52	44	0.022																																			
G3/8	0675 00 17	22	54	44	0.037																																			
G1/2	0675 00 21	27	65	53	0.072																																			

Silencers

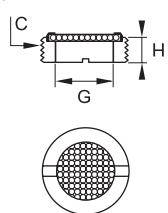

0671 Push-In Silencer

	Sintered bronze, nickel-plated brass 	ØD		G	L	L1	kg
		4	0671 04 00	13	41.5	24.5	0.015
		6	0671 06 00	15	48	29	0.024
		8	0671 08 00	15	49.5	29.5	0.025
		10	0671 10 00	19.5	68	43.5	0.052
		12	0671 12 00	20	68.5	43	0.052

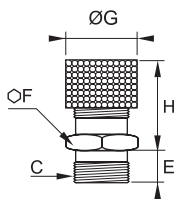

0677 Miniature Silencer, Male BSPP Thread

	Brass 	C		G	H	kg
		G1/8	0677 00 10	6	6	0.002
		G1/4	0677 00 13	8	6	0.003
		G3/8	0677 00 17	11	7	0.006
		G1/2	0677 00 21	14	8	0.010
		G3/4	0677 00 27	19	11	0.019
		G1	0677 00 34	25	10	0.025

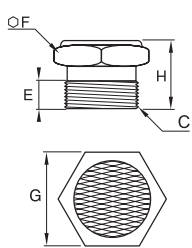

0672 Flow Control Silencer, Male BSPP Thread

	Sintered bronze, nickel-plated brass 	C		E	F	G	H min	H max	kg
		G1/8	0672 00 10	8	14	14	17	21	0.017
		G1/4	0672 00 13	8	17	17	20	24	0.029
		G3/8	0672 00 17	10	22	22	20	28	0.058
		G1/2	0672 00 21	12	27	27	28	37	0.094

0682 Compact Silencer, Male BSPP Thread

	Stainless steel 316L 	C		E	F	G	H	kg
		G1/8	0682 00 10	8	7	14	15	0.007
		G1/4	0682 00 13	8	7	17	15	0.011
		G3/8	0682 00 17	10	8	22	18	0.019
		G1/2	0682 00 21	12	10	27	22	0.038
		G3/4	0682 00 27	15	12	32	27	0.063
		G1	0682 00 34	18	14	38	32	0.117

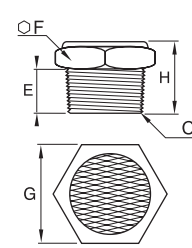
0683 Compact Silencer, Male NPT Thread

	Stainless steel 316L 	C		E	F	G	H	kg
		NPT1/8	0683 00 11	7	7	14	14	0.007
		NPT1/4	0683 00 14	11	7	17	18	0.014
		NPT3/8	0683 00 18	11	8	22	19	0.021
		NPT1/2	0683 00 22	15	10	27	25	0.043

